

ČAŠŤ

DIZAJNY

Číselné INID - kódy na označovanie bibliografických údajov (Standard WIPO ST. 80)

(11)	Číslo zapísaného dizajnu	(51)	Medzinárodné triedenie dizajnov
(15)	Dátum zápisu/predĺženia platnosti	(54)	Názov dizajnu
(18)	Predpokladaný dátum uplynutia platnosti zápisu/-predĺženia platnosti	(55)	Vyobrazenie dizajnu/vyobrazenie dizajnu po čiastočnom výmaze
(21)	Číslo prihlášky	(58)	Dátum záznamu v registri, napr. zmeny mena, zániku, výmazu a pod.
(22)	Dátum podania prihlášky	(62)	Číslo pôvodnej prihlášky v prípade vylúčenej prihlášky
(28)	Počet dizajnov	(72)	Meno pôvodcu (-ov)
(31)	Číslo prioritnej prihlášky	(73)	Meno (názov) majiteľa (-ov)
(32)	Dátum podania prioritnej prihlášky	(74)	Meno (názov) zástupcu (-ov)
(33)	Krajina alebo regionálna organizácia priority	(78)	Meno (názov) nového majiteľa (-ov) po prevode alebo prechode
(45)	Dátum sprístupnenia zapísaného dizajnu		
(46)	Dátum uplynutia odkladu zverejnenia		

Poznámka:

Číslo uvádzané pred kódom (51) znamená verziu Medzinárodného triedenia dizajnov.

Kódy na označovanie záhlaví oznámení publikovaných vo Vestníku ÚPV SR (Standard WIPO ST. 17)

FG4Q	Zapísané dizajny
FG4Q	Zapísané dizajny s odloženým zverejnením
FG4Q	Zverejnené zapísané dizajny po uplynutí doby odkladu zverejnenia
MA4Q	Zaniknuté zapísané dizajny vzdáním sa
MA4Q	Čiastočne zaniknuté zapísané dizajny vzdáním sa
MC4Q	Vymazané zapísané dizajny
MG4Q	Čiastočne vymazané zapísané dizajny
MK4Q	Zaniknuté zapísané dizajny uplynutím doby platnosti
ND4Q	Predĺženie platnosti zapísaných dizajnov
PC4Q	Prevody a prechody práv
PD4Q	Zmeny dispozičných práv na zapísané dizajny (zálohy)
PD4Q	Zmeny dispozičných práv na zapísané dizajny (ukončenie zálohov)
QB4Q	Licenčné zmluvy registrované
QC4Q	Ukončenie platnosti licenčných zmlúv
RL4Q	Odhätie ochrany a prepis majiteľa dizajnu (na základe rozhodnutia súdu)
TA4Q	Doplnenie pôvodcu (-ov)
TB4Q	Opravy mien
TC4Q	Zmeny mien
TD4Q	Opravy adries
TE4Q	Zmeny adries
TF4Q	Opravy dátumov
TG4Q	Opravy zatriedenia podľa Medzinárodného triedenia dizajnov
TH4Q	Opravy chýb alebo zmeny všeobecne
TK4Q	Opravy tlačových chýb vo Vestníku ÚPV SR

FG4Q

Zapísané dizajny

(11)	(51)	(11)	(51)	(11)	(51)	(11)	(51)
27860	12/07.00	27863	23/04.07	27866	25/01.10	27868	02/01.00
27861	19/01.00	27864	01/01.01	27867	05/05.01	27869	07/02.03
27862	23/99.00	27865	12/11.02				

9 (51) 01/01.01

(11) 27864

(15) 5.10.2012

(18) 26.9.2016

(21) 61-2011

(22) 26.9.2011

(72) Žitný František, Ing., Nitra, SK;

(73) ADIVIT, spol. s r.o., Nitra, SK;

(74) Máčajová Mária, Ing., Nitra, SK;

(54) Chlieb Dlháň

Určenie výrobku:

Výrobok, v ktorom je dizajn stelesnený, je určený ako potravinársky výrobok na konzumáciu.

(28) 2

(55)



1.1



2.1

9 (51) 02/01.00, 02/02.00

(11) 27868

(15) 8.10.2012

(18) 24.9.2017

(21) 51-2012

(22) 24.9.2012

(72) Jurikovičová Helena, Mgr., Bratislava, SK; Jurikovičová Otilia, Mgr., Bratislava, SK;

(73) Jurikovičová Helena, Mgr., Bratislava, SK; Jurikovičová Otilia, Mgr., Bratislava, SK;

(54) Kolekcia spodnej funkčnej bielizne, športových tričiek, rolákov, športových košiel, bünd a špeciálnej blúzy

Určenie výrobku:

Výrobky, v ktorých sú dizajny stelesnené, sú určené ako odevy pre pracovníkov MO SR, MV SR, záchranných a bezpečnostných zložiek.

(28) 82

(55)



1.1



1.2



2.1



2.2



6.1



3.1



7.1



3.2



8.1



4.1



9.1



5.1



10.1



15.1



11.1



16.1



12.1



16.2



13.1



14.1

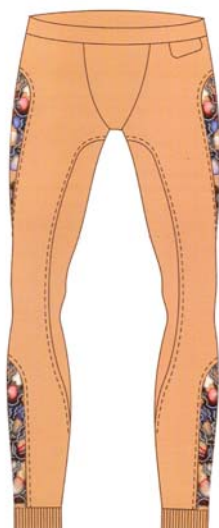

17.1



18.2

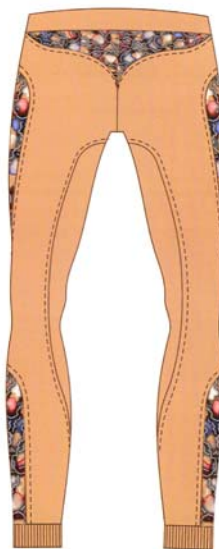

17.2



19.1



18.1



19.2

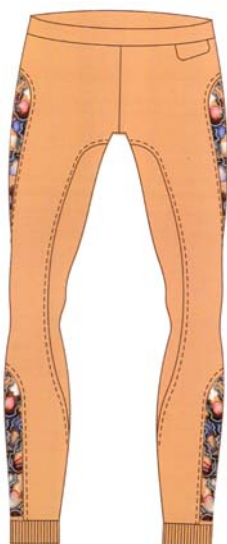

20.1



21.2

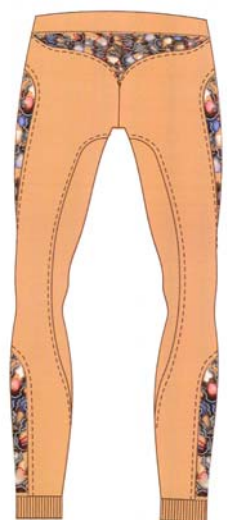

20.2



22.1



23.1



21.1



24.1



25.1



26.1



29.2



27.1



30.1



28.1



30.2



28.2



31.1



29.1



32.1



33.1



34.1



35.1



36.1



37.1

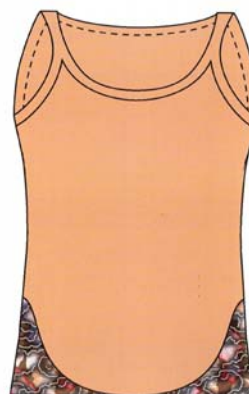

38.1



39.1



40.1



41.1



41.2



42.1



42.2



43.1



44.1



45.1



46.1



47.1



52.1



48.1



53.1



49.1



54.1



50.1



55.1



51.1



56.1



57.1



60.1



58.1



60.2



59.1



61.1



59.2



61.2



62.1



64.1



62.2



64.2



63.1



65.1



63.2



65.2



66.1



68.1



66.2



68.2



67.1



69.1



67.2



69.2



70.1



72.1



70.2



72.2



71.1



73.1



71.2



73.2



74.1



76.1



74.2



76.2



75.1



77.1



75.2



77.2



78.1



78.2



79.1

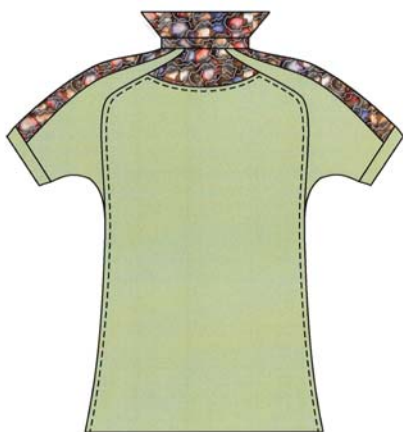

79.2



80.1

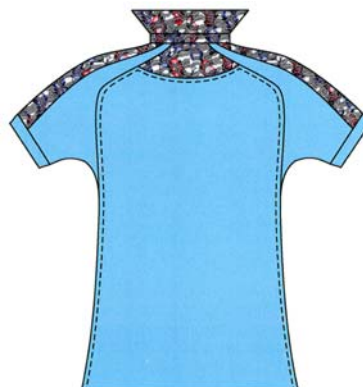

80.2



81.1



82.1

9 (51) 05/05.01

(11) 27867

(15) 5.10.2012

(18) 24.9.2017

(21) 50-2012

(22) 24.9.2012

(72) Jurikovičová Oľília, Mgr., Bratislava, SK; Jurikovičová Helena, Mgr., Bratislava, SK;

(73) Jurikovičová Oľília, Mgr., Bratislava, SK; Jurikovičová Helena, Mgr., Bratislava, SK;

(54) **Nový vzor na potlač tkaniny**

Určenie výrobku:

Výrobok, v ktorom je dizajn stelesnený, je nový vzor potlače tkaniny, určený ako identifikačný prvok odevov MO SR a MV SR.

(28) 4

(55)

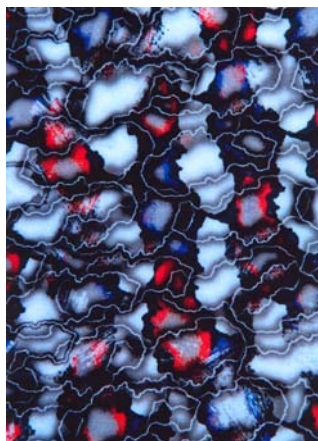

1.1



1.2

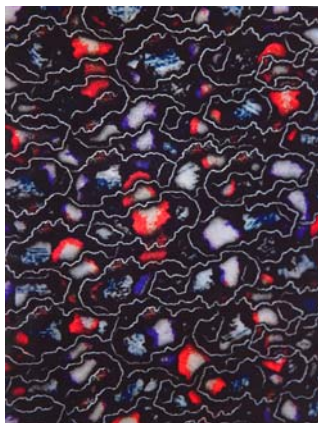

2.1

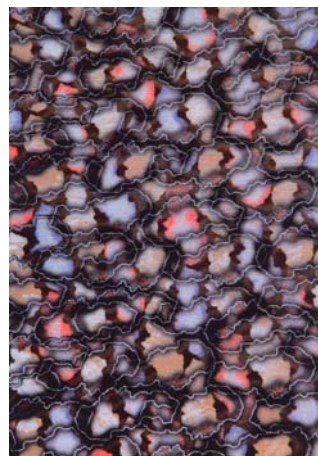

3.1



3.2



4.1

9 (51) 07/02.03

(11) 27869

(15) 8.10.2012

(18) 30.5.2017

(21) 5020-2012

(22) 30.5.2012

(72) Sabo Stanislav, Martin, SK;

(73) Sabo Stanislav, Martin, SK;

(74) Belička Ivan, Ing., Banská Bystrica, SK;

(54) Skladacia ohrievacia kanvica

Určenie výrobku:

Výrobok, v ktorom je dizajnu stelesnený, je skladacia ohrievacia kanvica, určená na ohrev kvapalných médií.

(28) 1

(55)



1.1



1.2



1.3



1.4



1.5

8 (51) 12/07.00**(11) 27860**

(15) 5.10.2012

(18) 16.10.2012

(21) 47-2007

(22) 16.10.2007

(72) Dobrovič Slavomír, Ing., Sabinov, SK; Dobrovič Ladislav, Sabinov, SK;

(73) TOMARK spol. s r. o., Prešov, SK;

(54) Ľahké športové lietadlo

Určenie výrobku:

Výrobok, v ktorom je dizajn stelesnený, predstavuje ľahké športové lietadlo.

(28) 1

(55)



1.1

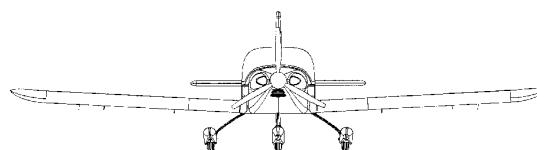

1.2

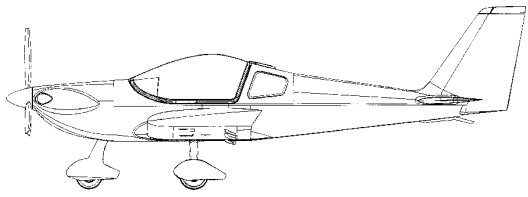

1.3

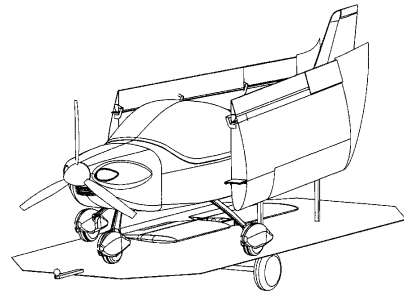

1.8

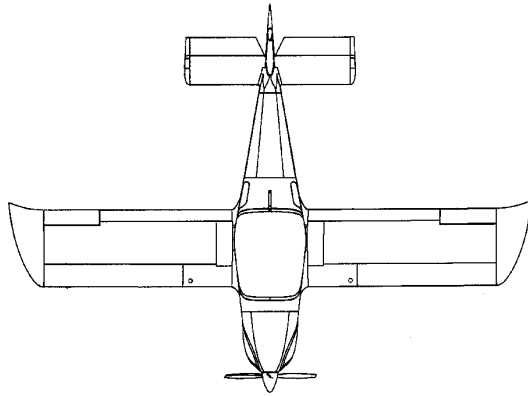

1.4



1.5

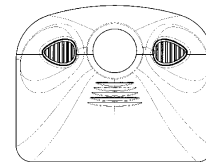

1.9

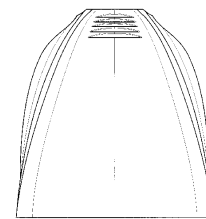

1.10

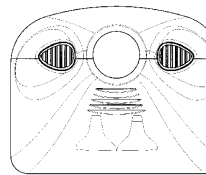

1.11

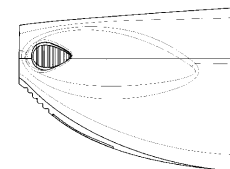
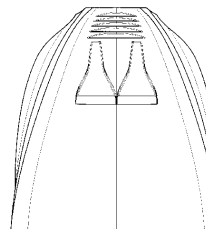

1.6

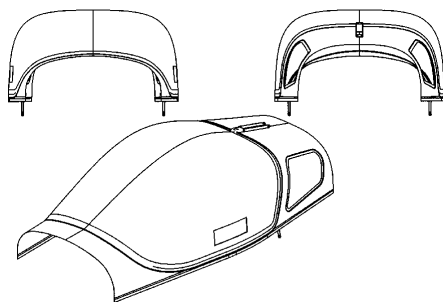

1.7

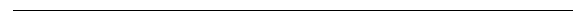

9 (51) 12/11.02

(11) 27865

(15) 5.10.2012

(18) 28.11.2016

(21) 77-2011

(22) 28.11.2011

(72) Kolláth Roland, Boldog, SK;

(73) Kolláth Roland, Boldog, SK;

(54) Motocykel a jeho časti

Určenie výrobku:

Výrobok, v ktorom je dizajn stelesnený, je určený ako Motocykel a jeho súčasti.

(28) 7

(55)



1.1



1.2



1.3



1.4



1.5



1.6



1.7



2.1



2.2



5.1



3.1



5.2



3.2



6.1



6.2



4.1

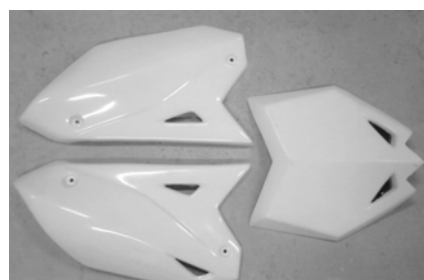

7.1



4.2

9 (51) 19/01.00

(11) 27861

(15) 5.10.2012

(18) 3.8.2014

(21) 5011-2009

(22) 3.8.2009

(72) Hron Karel, Vrchlabí, CZ;

(73) KRPA ENVELOPE, a.s., Hostinné, CZ;

(74) Litváková Edita, Ing., Bratislava, SK;

(54) **Doručkové obálky**

Určenie výrobku:

Výrobky, v ktorých je dizajn stelesnený, sú určene ako poštové obálky.

(28) 11

(55)

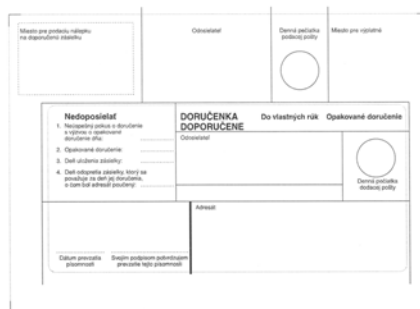

3.1



3.2

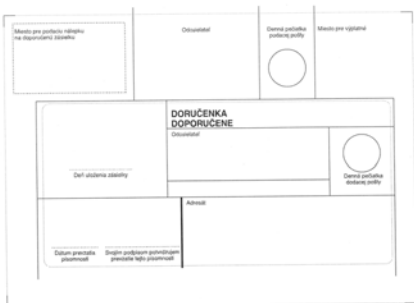

1.1

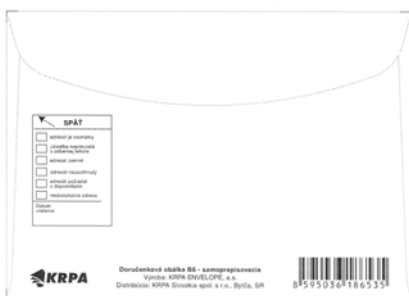

1.2

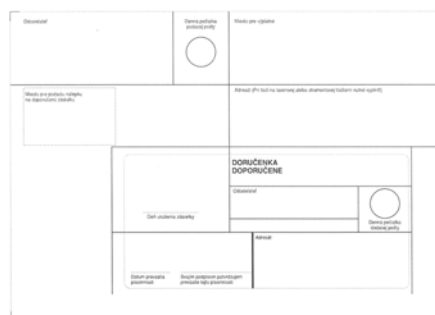

4.1



4.2

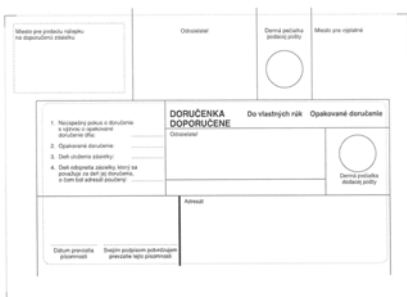

2.1



2.2

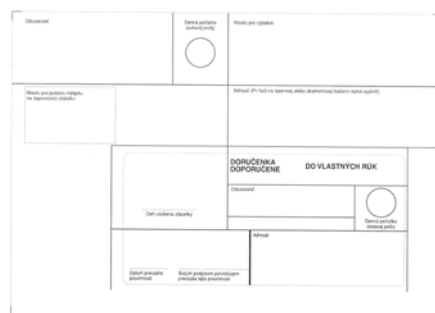

5.1



5.2

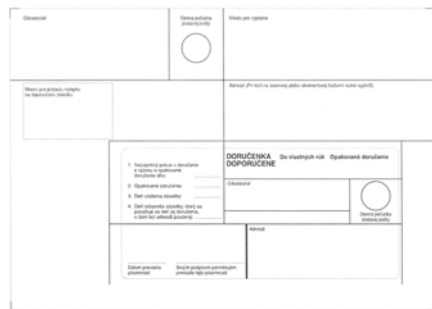

6.1



6.2

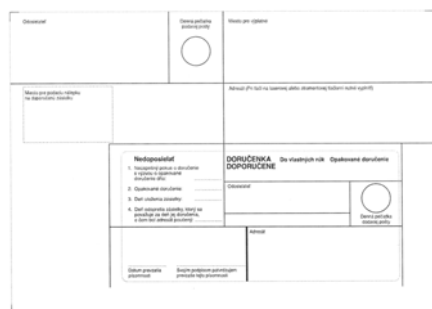

7.1



7.2

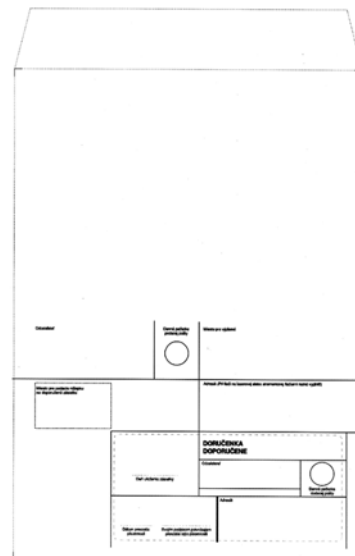

8.1

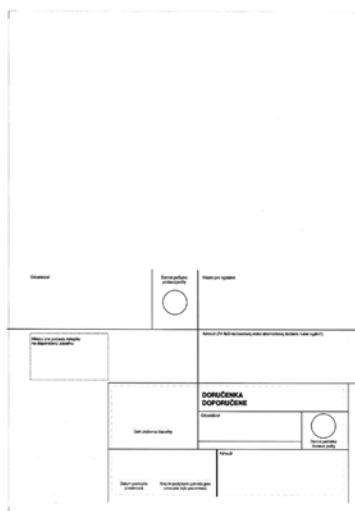

8.2

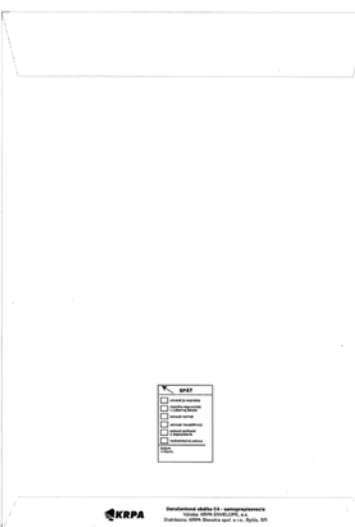

8.3

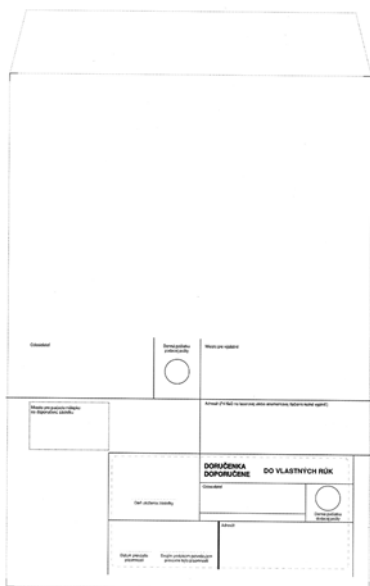

9.1

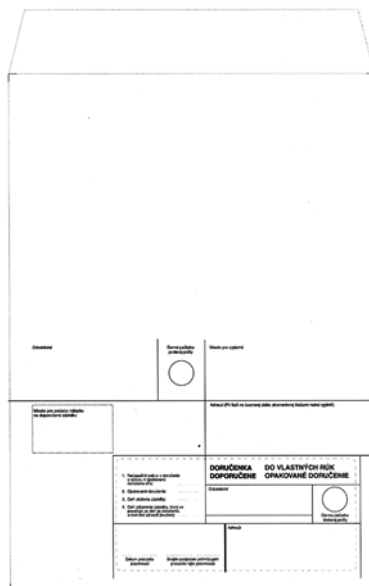

10.1

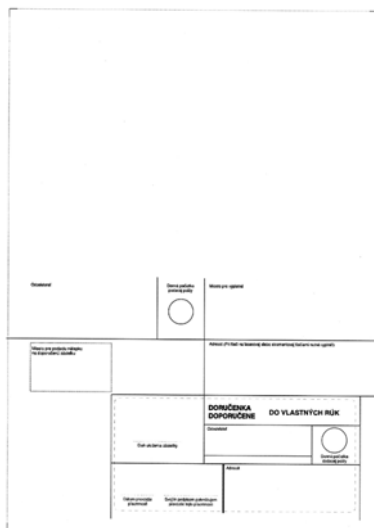

9.2

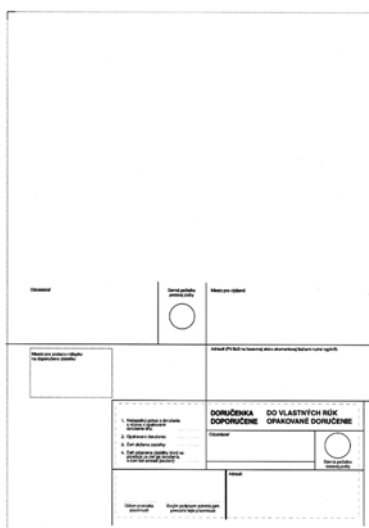

10.2

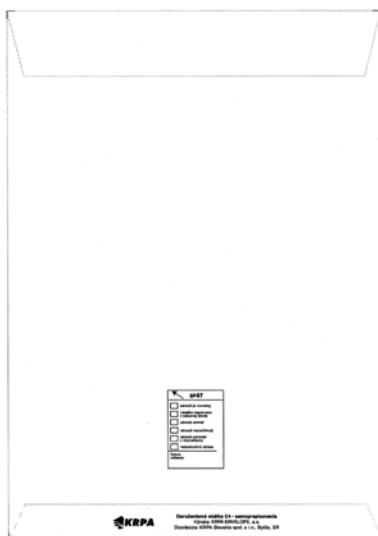

9.3



10.3

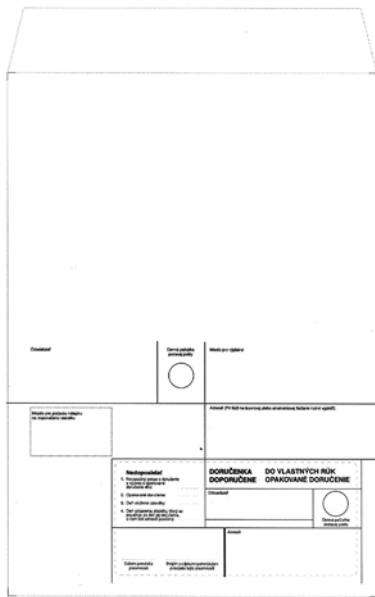

11.1

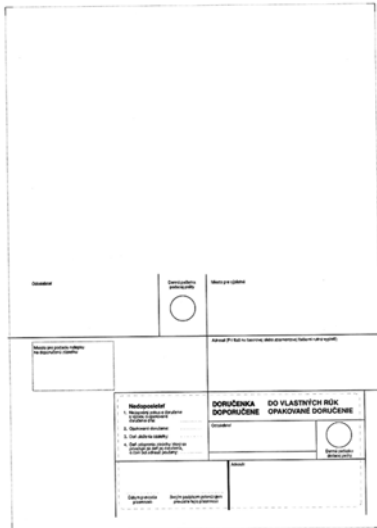

11.2

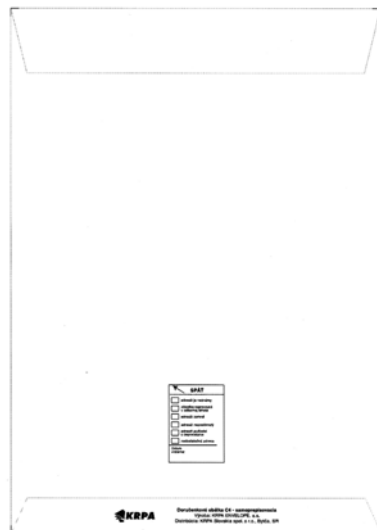

11.3

9 (51) 23/04.07

(11) 27863

(15) 5.10.2012

(18) 13.5.2016

(21) 27-2011

(22) 13.5.2011

(72) Vicen Ján, Banská Bystrica, SK;

(73) Vicen Ján, Banská Bystrica, SK;

(54) **Osviežovač vzduchu**

Určenie výrobku:

Výrobok, v ktorom je dizajn stelesnený, je osviežovač vzduchu v tvare hraníc krajiny - štátu, určený aj ako suvenír, reklamné médium, informačné médium, školská potreba, produkt cestovného ruchu, zábava skladačka - puzzle.

(28) 3

(55)

D1



1.1

D2



2.1

D 3



3.1

9 (51) 23/99.00

(11) 27862

(15) 5.10.2012

(18) 22.12.2014

(21) 5028-2009

(22) 22.12.2009

(72) Erby Marián, Ing., Košice, SK;

(73) ERBY-STATIKA STAVIEB, s.r.o., Košice, SK;

(74) Šujanová Mária, Ing., Bratislava, SK;

(54) **Kĺzná podpera**

Určenie výrobku:

Výrobok je určený ako vybavenie ježkových komôr pri veľkorozmerových potrubíach na prepravu plynu a tekutín.

(28) 1

(55)

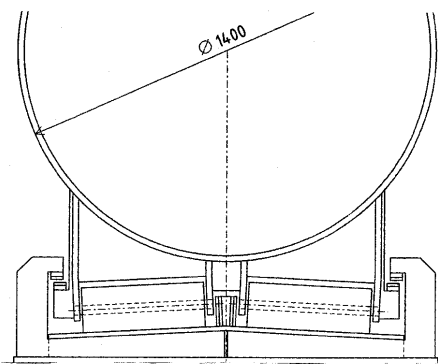

1.1

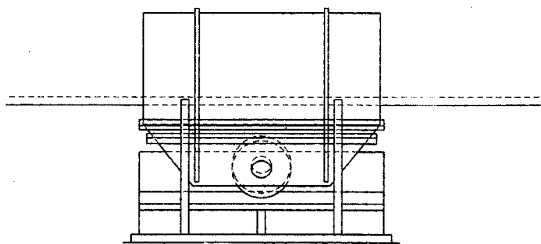

1.2

9 (51) 25/01.10

(11) 27866

(15) 5.10.2012

(18) 22.5.2017

(21) 34-2012

(22) 22.5.2012

(72) Kvočák Vincent, doc. Ing., CSs., Košice, SK;

(73) Dubecký Daniel, Ing., Levoča, SK; Beke Pavol, Ing., PhD., Košice, SK;

(74) Technická univerzita v Košiciach, Stavebná fakulta, Košice, SK;

(74) Mišľanová Mária, Košice, SK;

(54) **Nosník**

Určenie výrobku:

Výrobok, v ktorom je dizajn stelesnený, je oceľový nosník, určený na spolupôsobenie s betónom ako podporná zložená konštrukcia - spriahnutý nosník.

(28) 3

(55)

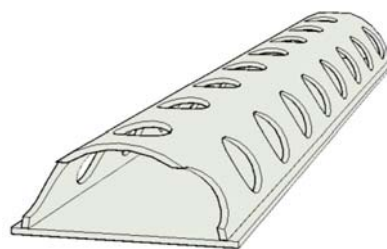

1.1

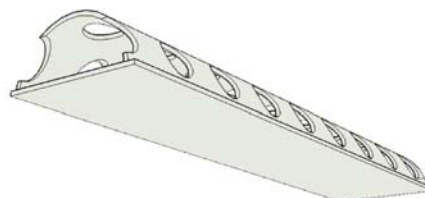

1.2

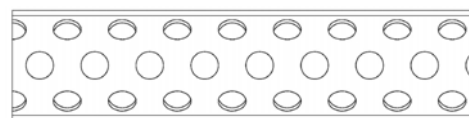

1.3



1.4

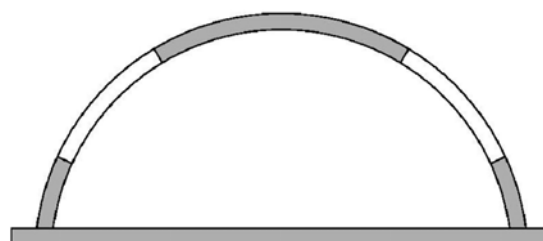

1.5



1.6

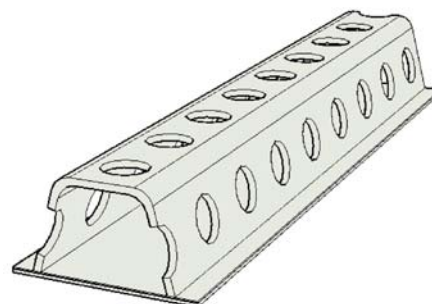

2.1

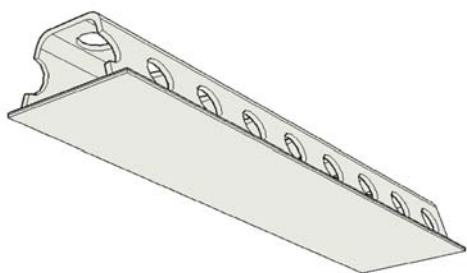

2.2

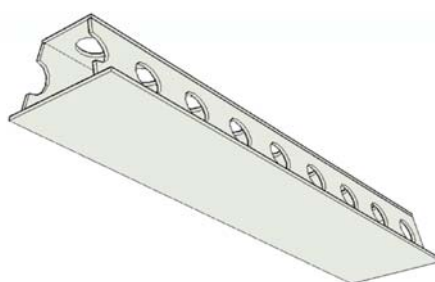

3.2

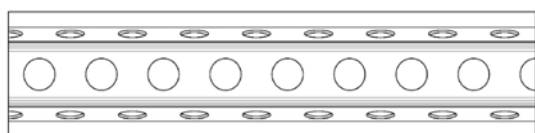

2.3

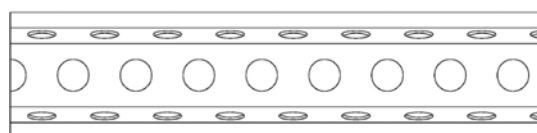

3.3



2.4



3.4

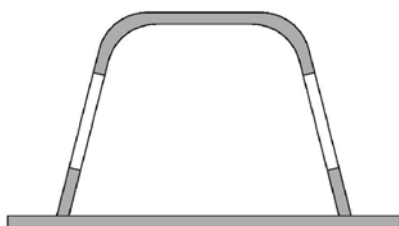

2.5

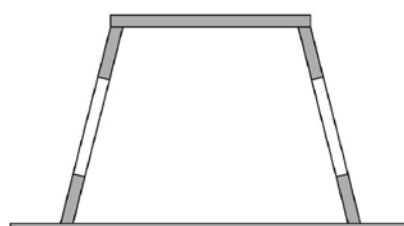

3.5



2.6



3.6

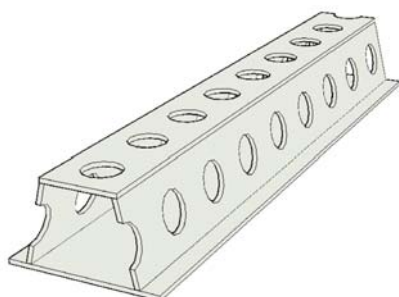

3.1

(51)	(11)	(51)	(11)	(51)	(11)	(51)	(11)
01/01.01	27864	07/02.03	27869	19/01.00	27861	23/99.00	27862
02/01.00	27868	12/07.00	27860	23/04.07	27863	25/01.10	27866
05/05.01	27867	12/11.02	27865				

MK4Q Zaniknuté zapísané dizajny uplynutím doby platnosti

(11)	Dátum zániku	(11)	Dátum zániku	(11)	Dátum zániku	(11)	Dátum zániku
25466	16.10.2012	25538	29.10.2012	27349	02.03.2012	27377	20.03.2012
25467	16.10.2012	26539	08.03.2012	27351	19.03.2012	27446	19.03.2012
25469	16.10.2012	26708	26.03.2012	27360	27.03.2012	27447	20.03.2012
25470	16.10.2012	27338	14.03.2012	27362	02.03.2012		
25521	13.10.2012	27339	14.03.2012	27363	13.03.2012		
25534	03.10.2012	27340	14.03.2012	27364	21.03.2012		

MC4Q Vymazané zapísané dizajny**(11) 27585**

(21) 29-2009

(22) 10.6.2009

(54) Etiketa na označovanie potravinárskych výrobkov

Určenie výrobku:

Výrobok, v ktorom je dizajn stelesnený, je etiketa na označovanie potravinárskych výrobkov, určená na označovanie a uzatváranie kelímokov potravinárskych výrobkov.

(58) 2.10.2012

(11) 27602

(21) 36-2009

(22) 3.8.2009

(54) Obal s etiketou na potravinársky výrobok

Určenie výrobku:

Výrobkom, v ktorom je dizajn stelesnený, je obal s etiketou na potravinársky výrobok, určený na označovanie a uskladňovanie potravinárskych výrobkov.

(58) 4.9.2012

ND4Q Predĺženie platnosti zapísaných dizajnov

(11) (51)

26660 04/02.01

27428 10/04.03

7 (51) 04/02.01**(11) 26660**

(15) 4.6.2003

(18) 21.11.2017

(21) 255-2002

(22) 21.11.2002

(73) GlaxoSmithKline Consumer Healthcare GmbH & Co. KG, Buehl (Baden), DE;

(54) Zubná kefka

Určenie výrobku:

Výrobok, v ktorom je dizajn stelesnený alebo na ktorom bude aplikovaný, je určený ako zubná kefka.

8 (51) 10/04.03**(11) 27428**

(15) 13.3.2008

(18) 16.10.2017

(21) 46-2007

(22) 16.10.2007

(73) OSAKI ELECTRIC CO., LTD., Shinagawa-ku, Tokyo, JP;

(54) Watthodinový elektrometer

Určenie výrobku:

Výrobok, v ktorom bude dizajn stelesnený alebo na ktorom bude aplikovaný, je určený ako elektrometer na meranie účinnej elektrickej energie.

(51) (11)

04/02.01 26660

10/04.03 27428

TC4Q**Zmeny mien**

- (11) 27072
(21) 135-2004
(73) W.A.G. payment solutions, a.s., Praha, CZ;
(58) 16.10.2012
-