

**ČAŠŤ**

**DIZAJNY**

### Číselné INID - kódy na označovanie bibliografických údajov (Štandard WIPO ST. 80)

(11)	Číslo zapísaného dizajnu	(51)	Medzinárodné triedenie dizajnov
(15)	Dátum zápisu/predĺženia platnosti	(54)	Názov dizajnu
(18)	Predpokladaný dátum uplynutia platnosti zápisu/predĺženia platnosti	(55)	Vyobrazenie dizajnu/vyobrazenie dizajnu po čiastočnom výmaze
(21)	Číslo prihlášky	(58)	Dátum záznamu v registri, napr. zmeny mena, zániku, výmazu a pod.
(22)	Dátum podania prihlášky	(62)	Číslo pôvodnej prihlášky v prípade vylúčenej prihlášky
(24)	Dátum nadobudnutia účinkov zapísaného dizajnu	(71)	Meno (názov) a adresa prihlasovateľa (-ov)
(31)	Číslo prioritnej prihlášky	(72)	Meno pôvodcu (-ov)
(32)	Dátum podania prioritnej prihlášky	(73)	Meno (názov) a adresa majiteľa (-ov)
(33)	Krajina alebo regionálna organizácia priority	(74)	Meno (názov) a adresa zástupcu (-ov)
(45)	Dátum sprístupnenia zapísaného dizajnu	(78)	Meno (názov) a adresa nového majiteľa (-ov) po prevode alebo prechode
(46)	Dátum uplynutia odkladu zverejnenia		

Poznámka:

Číslo uvádzané pred kódom (51) znamená verziu Medzinárodného triedenia dizajnov.

### Kódy na označovanie záhlaví oznámení publikovaných vo Vestníku ÚPV SR (Štandard WIPO ST. 17)

<b>FG1K</b>	Zapísané úžitkové vzory
<b>MA1K</b>	Zaniknuté úžitkové vzory vzdaním sa
<b>MC1K</b>	Vymazané úžitkové vzory
<b>MG1K</b>	Čiastočne vymazané úžitkové vzory
<b>MK1K</b>	Zaniknuté úžitkové vzory uplynutím doby platnosti
<b>MM1K</b>	Zaniknuté úžitkové vzory pre nezaplatenie poplatkov za predĺženie platnosti
<b>ND1K</b>	Prvé predĺženie platnosti úžitkových vzorov
<b>ND1K</b>	Druhé predĺženie platnosti úžitkových vzorov
<b>PC1K</b>	Prevody a prechody práve
<b>PD1K</b>	Zmeny dispozičných práv na úžitkové vzory (zálohy)
<b>QB1K</b>	Licenčné zmluvy registrované
<b>OC1K</b>	Ukončenie platnosti licencie
<b>SB1K</b>	Zapísané úžitkové vzory do registra po odtajnení
<b>TA1K</b>	Opravy mien pôvodcov
<b>TB1K</b>	Opravy mien
<b>TC1K</b>	Zmeny mien
<b>TD1K</b>	Opravy adries
<b>TE1K</b>	Zmeny adries
<b>TF1K</b>	Opravy dátumov
<b>TG1K</b>	Opravy zatriedenia podľa MPT
<b>TH1K</b>	Opravy chýb alebo zmeny všeobecne
<b>TK1K</b>	Opravy tlačových chýb vo Vestníku ÚPV SR

## FG4Q

## Zapísané dizajny

(11)	(51)	(11)	(51)	(11)	(51)	(11)	(51)
26899	09/01.01	26904	09/01.01	26909	14/01.04	26914	04/02.01
26900	09/01.01	26905	09/01.03	26910	08/08.02	26915	24/04.02
26901	11/01.06	26906	12/15.01	26911	01/01.01	26916	21/01.08
26902	12/08.03	26907	28/03.03	26912	21/01.08	26917	08/08.03
26903	25/02.01	26908	19/04.01	26913	21/01.06	26918	12/13.10

**8 (51) 01/01.01****(11) 26911**

(15) 22.6.2004

(18) 26.11.2008

(21) 224-2003

(22) 26.11.2003

(24) 22.6.2004

(45) 3.8.2004

(72) Nesládek Peter, Nitrianske Pravno, SK;

(73) NESPA, s. r. o., Malinová, SK;

(74) Kubínyi Peter, Bc., Trenčín, SK;

**(54) Kúpeľná oblátka**

Určenie výrobku: Výrobok, v ktorom je dizajn stelesnený, je určený na použitie ako kúpeľná oblátka.

(28) 3

(55)



1.1



2.1



3.1

**8 (51) 04/02.01****(11) 26914**

(15) 22.6.2004

(18) 22.12.2008

(21) 238-2003

(22) 22.12.2003

(24) 22.6.2004

(31) 3013317

(32) 25.6.2003

(33) GB

(45) 3.8.2004

(72) Geiberger Christoph, Herne, DE;

(73) GlaxoSmithKline Consumer Healthcare GmbH &amp; Co. KG, Buehl (Baden), DE;

(74) Majlingová Marta, Ing., Bratislava, SK;

**(54) Zubná kefka**

Určenie výrobku: Výrobok, v ktorom bude dizajn stelesnený alebo na ktorom bude aplikovaný, je určený ako zubná kefka na mechanické čistenie zubov.

(28) 1

(55)



1.1



1.2



1.3



1.4



1.5

8 (51) 08/08.02

(11) 26910

(15) 22.6.2004

(18) 18.11.2008

(21) 218-2003

(22) 18.11.2003

(24) 22.6.2004

(31) PVZ 2003-34815

(32) 14.8.2003

(33) CZ

(45) 3.8.2004

(72) Petráň Jan, Bánov, CZ; Liška Jozef, Brno, CZ;

(73) KOZAP Uh. Brod - zbraně a střílivo, spol. s r. o.,  
Bánov, CZ;

(74) Kováčik Štefan, Ing., Bratislava, SK;

(54) **Spojovací prvok**

Určenie výrobku: Výrobok podľa dizajnu, v ktorom je stelesnené vonkajšie tvarové riešenie spojovacieho prvku je určené k rozoberateľnému spojeniu pušky a puškového ďalekohľadu, tzv. puškohľadu.

(28) 1

(55)



1.1



1.2

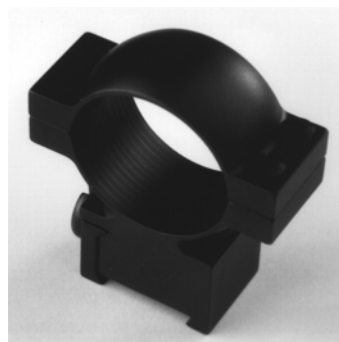

1.3

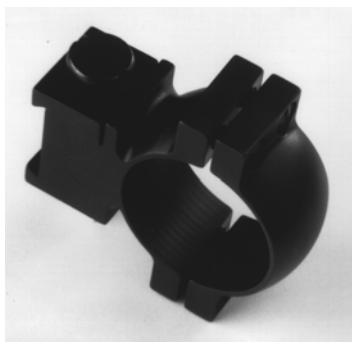

1.4



1.5

**8 (51) 08/08.03****(11) 26917**

(15) 22.6.2004

(18) 31.12.2008

(21) 241-2003

(22) 31.12.2003

(24) 22.6.2004

(45) 3.8.2004

(72) Kunc Jozef, Ing., Košice, SK; Szegedy Stanislav, Ing., Košice, SK;

(73) OBAL - SERVIS, a. s. Košice, Košice, SK;

(74) Regina Ivan, Ing., Košice, SK;

**(54) Vnútrotná príruha, najmä na balenie zvitkov plechu**

Určenie výrobku: Vnútrotná príruha, najmä na balenie zvitkov plechu je jednou z častí obalu zvitku plechu. Vkladá sa do obidvoch čiel jadra zvitku plechu po jeho zabalení - navlečení ochranných vrstiev obalu na povrch zvitku. Výrobok je určený na ochranu vnútorných vinutí zvitku plechu pred poškodením, čiastočne počas ukončenia balenia pri opáskovaní obalu a následne počas manipulácie so zvitkom a pri jeho preprave.

(28) 1

(55)



1.1

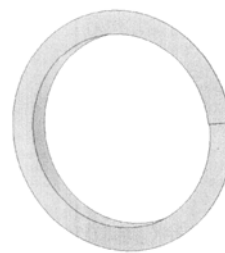

1.2

**8 (51) 09/01.01****(11) 26904**

(15) 4.6.2004

(18) 6.11.2008

(21) 206-2003

(22) 6.11.2003

(24) 4.6.2004

(31) 000032610

(32) 12.5.2003

(33) EM

(45) 3.8.2004

(72) Koskinen Harri, 00510 Helsinki, FI;

(73) Finlandia Vodka Worldwide Ltd, 00180 Helsinki, FI;

(74) ROTT, RŮŽIČKA &amp; GUTTMANN, v. o. s., Bratislava, SK;

**(54) Fľaše**

Určenie výrobku: Výrobkom sú 3 dizajny fľaše.

(28) 3

(55)



1.1

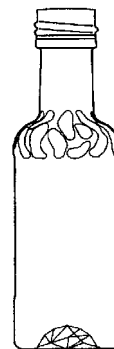

1.2

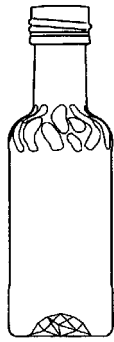

1.3

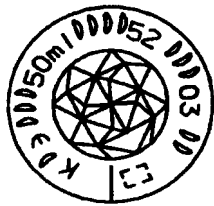

1.4

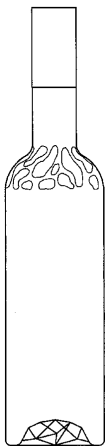

2.1



2.2



2.3

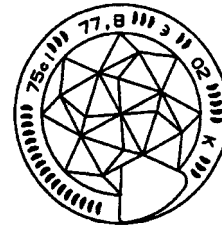

2.4

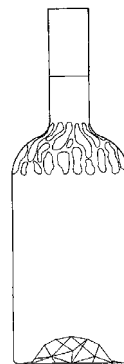

3.1

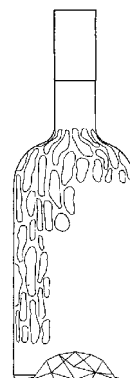

3.2

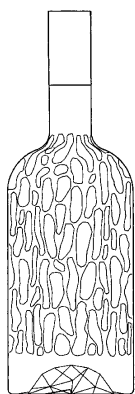

3.3

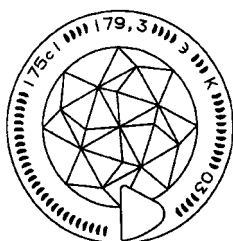

3.4

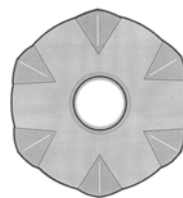

1.2



2.1

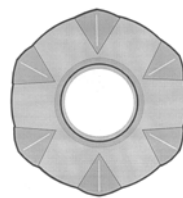

2.2

**8 (51) 09/01.01****(11) 26899**

(15) 2.6.2004

(18) 16.10.2008

(21) 191-2003

(22) 16.10.2003

(24) 2.6.2004

(45) 3.8.2004

(72) Németh Jozef, Bučany, SK;

(73) Euro Cola, s. r. o., Trnava, SK;

(74) Porubčan Róbert, Ing., Ivanka pri Dunaji, SK;

**(54) Fľaša**

Určenie výrobku: Výrobok, v ktorom je dizajn stelesnený, je fľaša na nápoje, predovšetkým plastová fľaša na nápoje.

(28) 2

(55)



1.1

**8 (51) 09/01.01****(11) 26900**

(15) 2.6.2004

(18) 13.11.2008

(21) 215-2003

(22) 13.11.2003

(24) 2.6.2004

(45) 3.8.2004

(72) Černák Matúš, Veľký Krtíš, SK;

(73) B. M. A., spol. s r. o., Bratislava, SK;

(74) Hojčuš Peter, Ing., Bratislava, SK;

**(54) Fľaša**

Určenie výrobku: Výrobok podľa dizajnu je určený ako obal a nádoba na nápoje.

(28) 1

(55)



1.1

**8 (51) 09/01.03**

**(11) 26905**

(15) 4.6.2004

(18) 16.10.2008

(21) 190-2003

(22) 16.10.2003

(24) 4.6.2004

(31) 403 03 062.5

(32) 17.4.2003

(33) DE

(45) 3.8.2004

(72) Danne Markus, Pulheim, DE; Hitzbleck Alexandra, Ratingen, DE; Seidenschur Katja, Düsseldorf, DE;

(73) Henkel Kommanditgesellschaft auf Aktien, Düsseldorf, DE;

(74) Majlingová Marta, Ing., Bratislava, SK;

**(54) Nádobka**

Určenie výrobku: Výrobok, v ktorom je dizajn stelesnený alebo na ktorom bude aplikovaný, je určený ako nádobka na kozmetické prípravky alebo farmaceutické prípravky.

(28) 2

(55)



1.1



1.2



1.3



1.4



2.1



2.2



2.3



2.4

**8 (51) 11/01.06**

**(11) 26901**

(15) 4.6.2004

(18) 11.9.2008

(21) 168-2003

(22) 11.9.2003

(24) 4.6.2004

(31) MU 851/2003 - MU 871/2003, 69372

(32) 17.3.2003, 29.8.2003

(33) AT, EM

(45) 3.8.2004

(72) Steiner Klaus, Mils, AT; Scheffknecht Markus, Vomp, AT;

(73) Swarovski Aktiengesellschaft, FL-9495 Triesen, Lichtenštajsko, LI;

(74) ROTT, RŮŽIČKA & GUTTMANN, v. o. s., Bratislava, SK;

**(54) Přírodní ozdobné kamene, umelé ozdobné kamene, ozdobné predmety zo skla**

Určenie výrobku: Výrobkom je 42 dizajnov ozdobných kameňov na dekoratívne účely.



(28) 42  
(55)

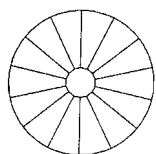

1.1

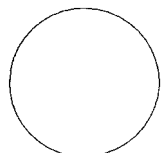

1.2

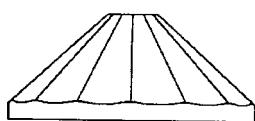

1.3

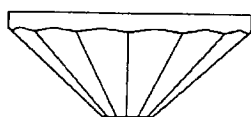

1.4

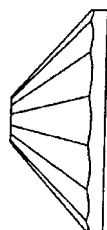

1.5

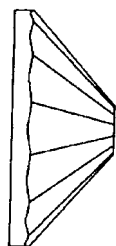

1.6

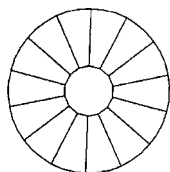

2.1

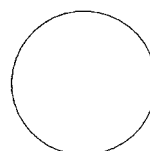

2.2

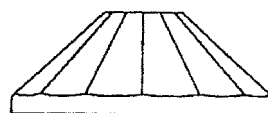

2.3



2.4

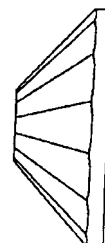

2.5

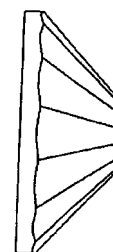

2.6

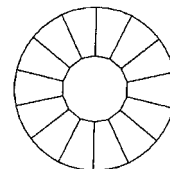

3.1

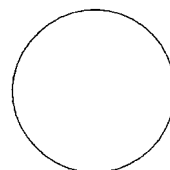

3.2

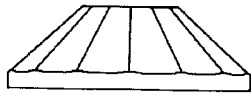

3.3

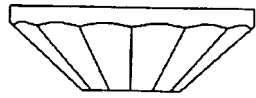

3.4

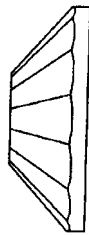

3.5

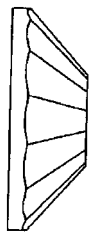

3.6

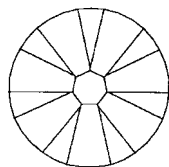

4.1

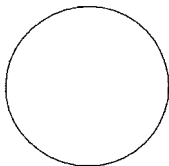

4.2

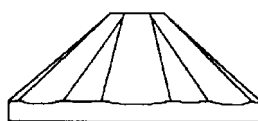

4.3

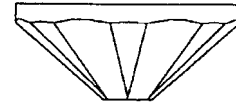

4.4

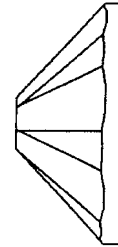

4.5

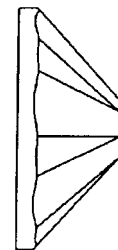

4.6

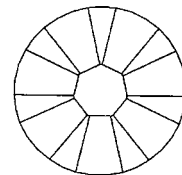

5.1

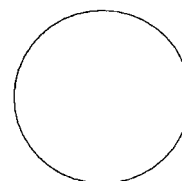

5.2

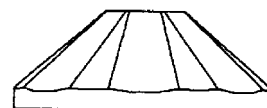

5.3

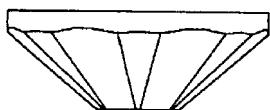

5.4

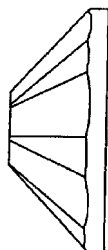

5.5

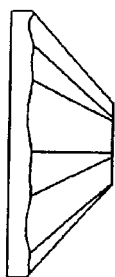

5.6

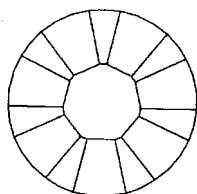

6.1

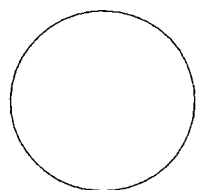

6.2

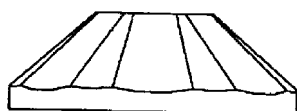

6.3



6.4

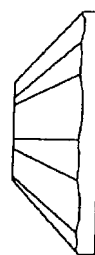

6.5



6.6

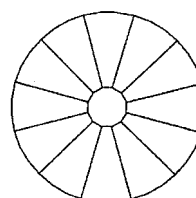

7.1

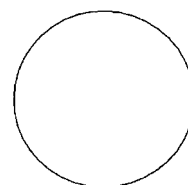

7.2

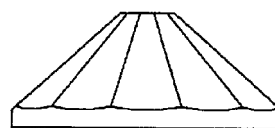

7.3

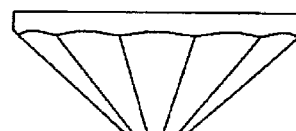

7.4

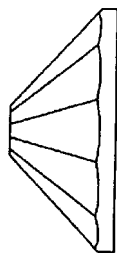

7.5

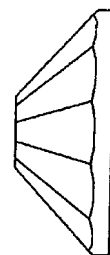

8.5

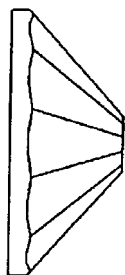

7.6



8.6

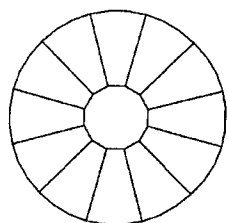

8.1

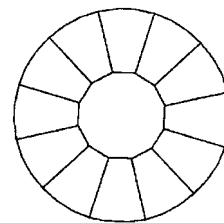

9.1

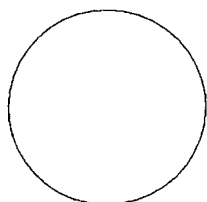

8.2

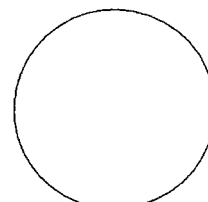

9.2

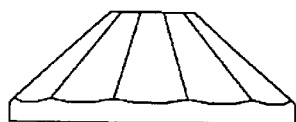

8.3

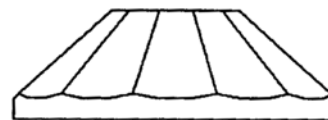

9.3

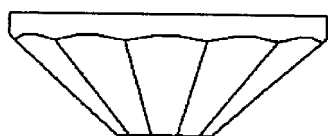

8.4



9.4

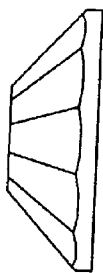

9.5

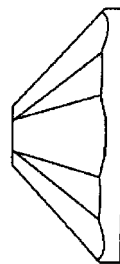

10.5



9.6



10.6

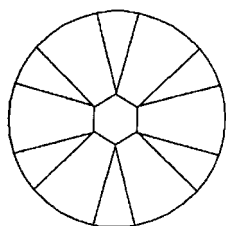

10.1

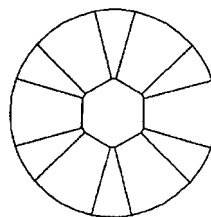

11.1

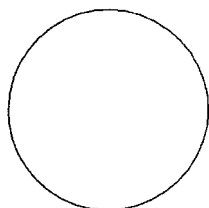

10.2

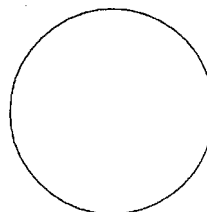

11.2

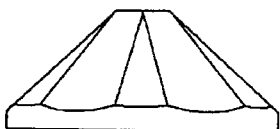

10.3

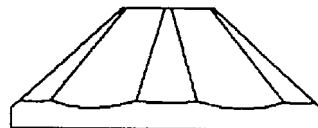

11.3

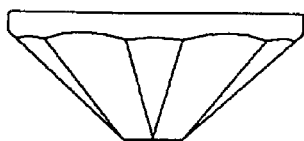

10.4



11.4

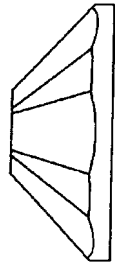

11.5

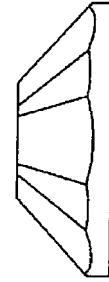

12.5



11.6



12.6

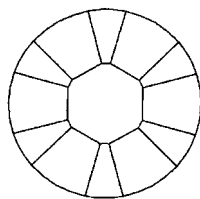

12.1

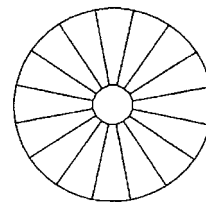

13.1

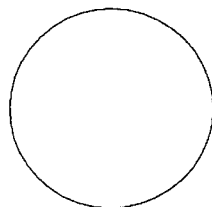

12.2

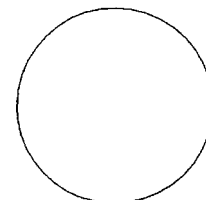

13.2

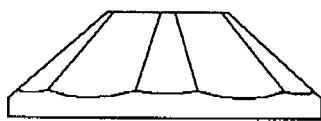

12.3

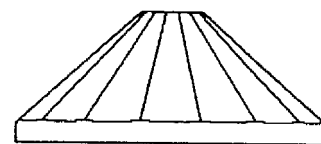

13.3

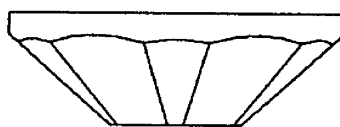

12.4

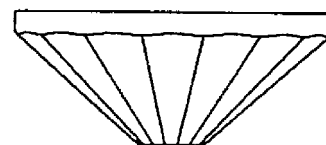

13.4

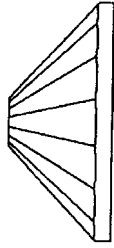

13.5

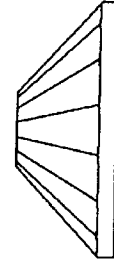

14.5

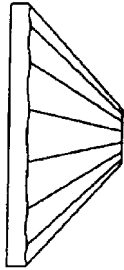

13.6

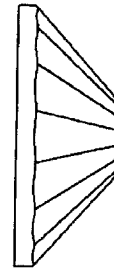

14.6

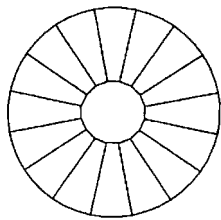

14.1

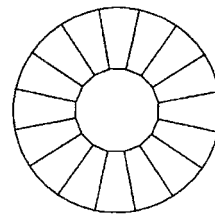

15.1

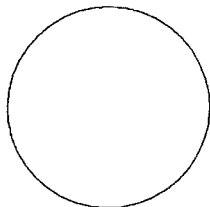

14.2

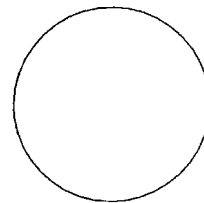

15.2

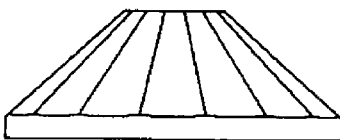

14.3

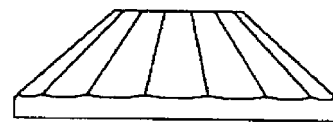

15.3

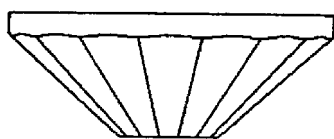

14.4

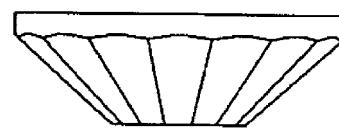

15.4

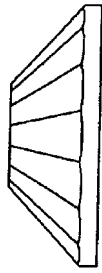

15.5

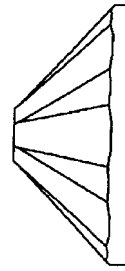

16.5

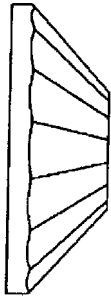

15.6

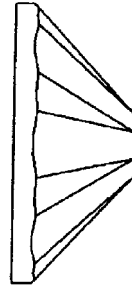

16.6

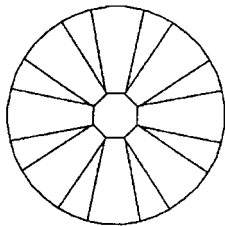

16.1

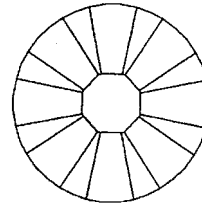

17.1

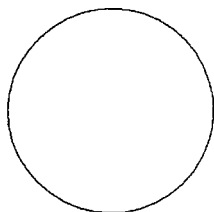

16.2

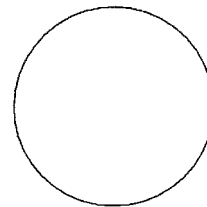

17.2

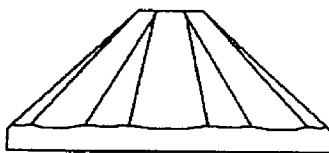

16.3

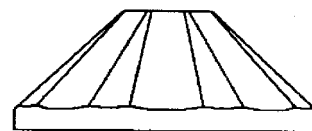

17.3

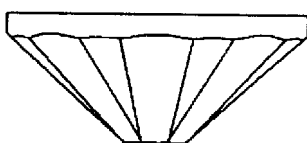

16.4

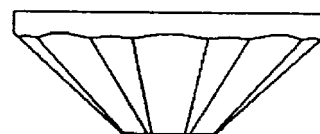

17.4



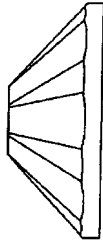

17.5

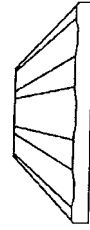

18.5

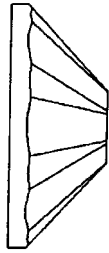

17.6



18.6

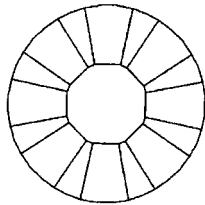

18.1

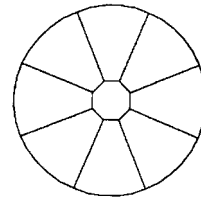

19.1

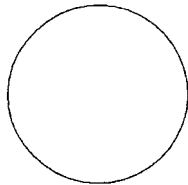

18.2

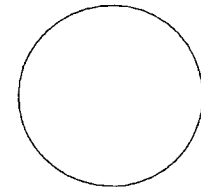

19.2

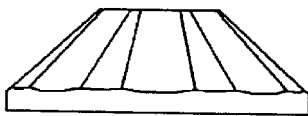

18.3

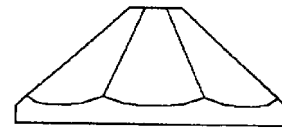

19.3

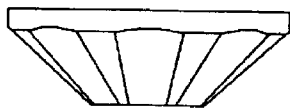

18.4

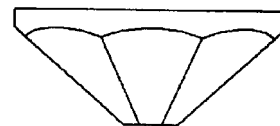

19.4

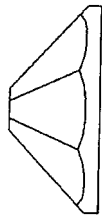

19.5

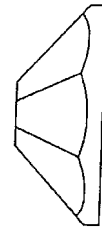

20.5



19.6



20.6

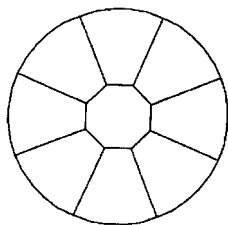

20.1

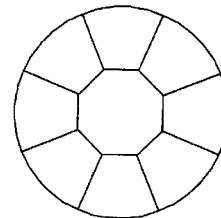

21.1

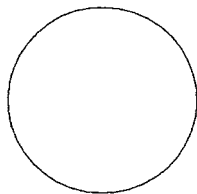

20.2

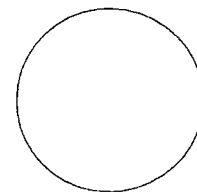

21.2

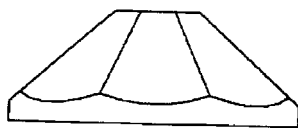

20.3



21.3

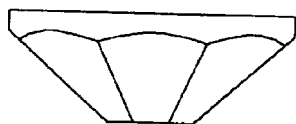

20.4



21.4

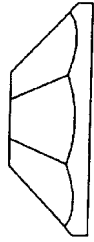

21.5



21.6

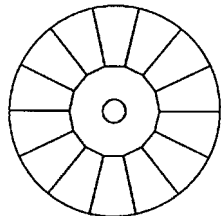

22.1

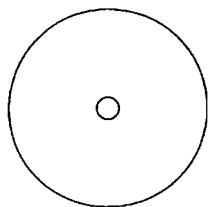

22.2



22.3



22.4

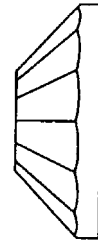

22.5



22.6

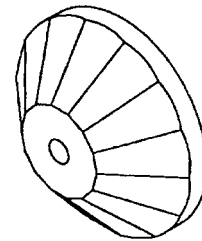

22.7

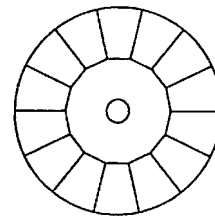

23.1

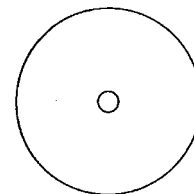

23.2



23.3

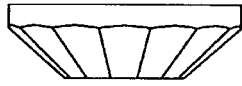

23.4



24.3

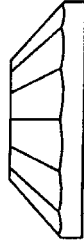

23.5



24.4



23.6



24.5

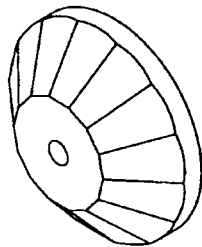

23.7



24.6

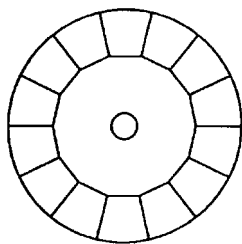

24.1

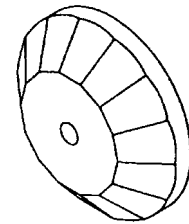

24.7

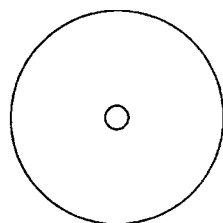

24.2

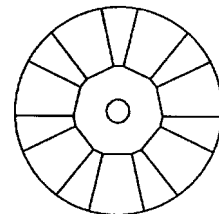

25.1

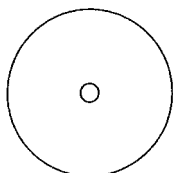

25.2

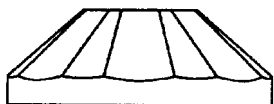

25.3



25.4

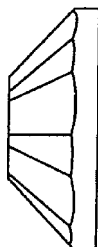

25.5



25.6

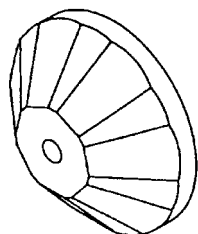

25.7

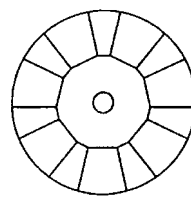

26.1

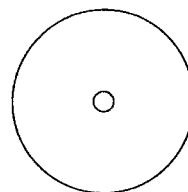

26.2

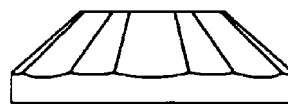

26.3

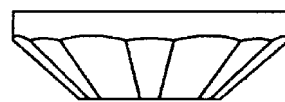

26.4

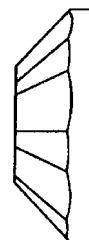

26.5



26.6

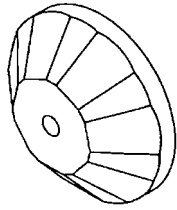

26.7



27.6

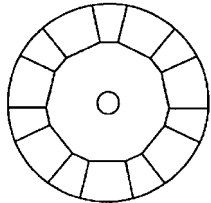

27.1

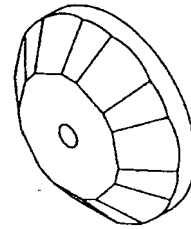

27.7

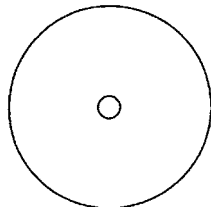

27.2

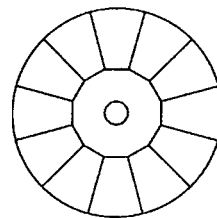

28.1

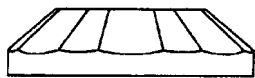

27.3

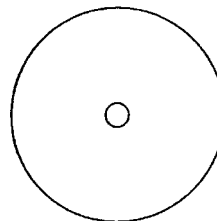

28.2



27.4

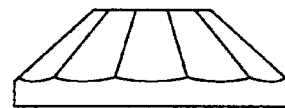

28.3



27.5



28.4

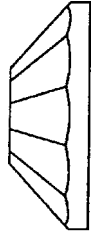

28.5



28.6

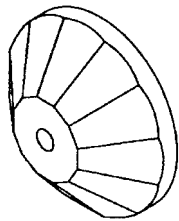

28.7

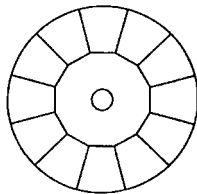

29.1

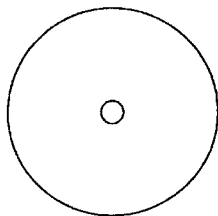

29.2

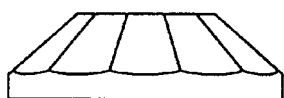

29.3

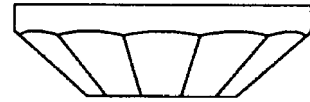

29.4

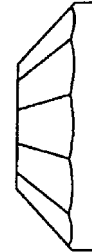

29.5



29.6

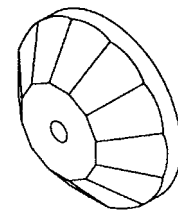

29.7

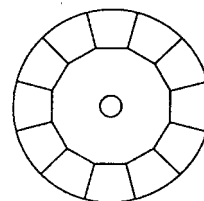

30.1

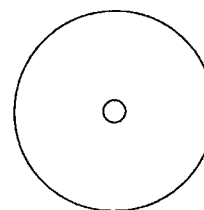

30.2



30.3

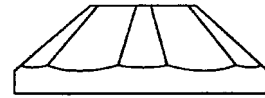

31.3

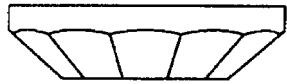

30.4

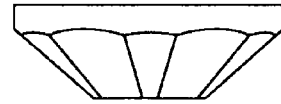

31.4



30.5

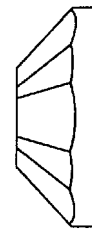

31.5



30.6



31.6

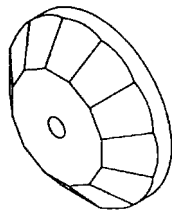

30.7

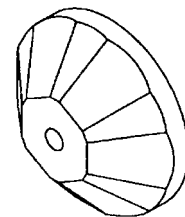

31.7

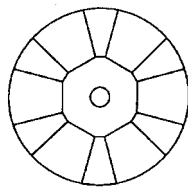

31.1

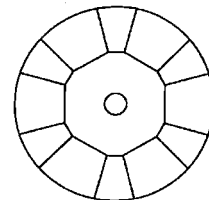

32.1

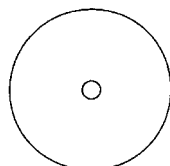

31.2

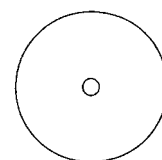

32.2



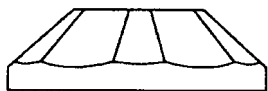

32.3

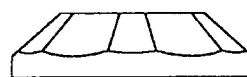

33.3



32.4



33.4



32.5

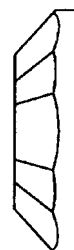

33.5



32.6



33.6

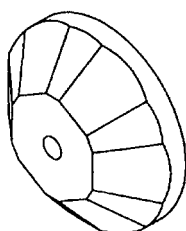

32.7

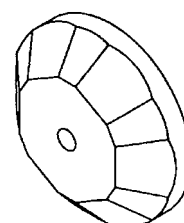

33.7

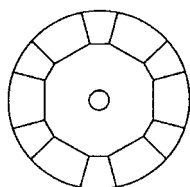

33.1

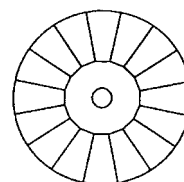

34.1

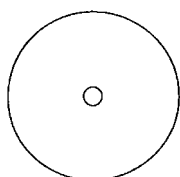

33.2

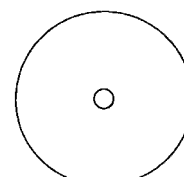

34.2

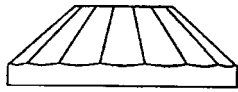

34.3

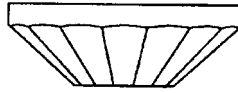

34.4



34.5



34.6

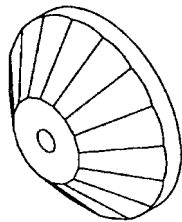

34.7

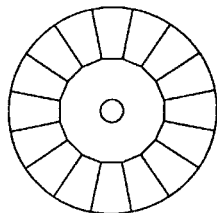

35.1

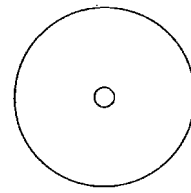

35.2

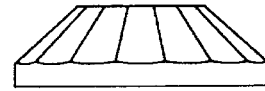

35.3

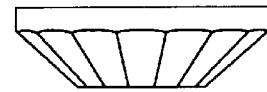

35.4

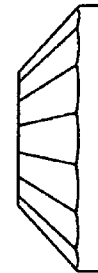

35.5



35.6

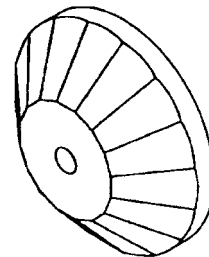

35.7

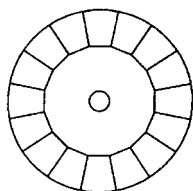

36.1

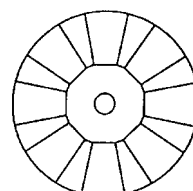

37.1

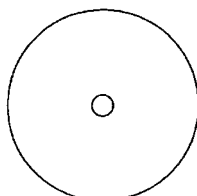

36.2

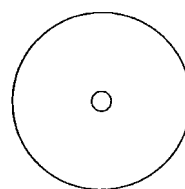

37.2

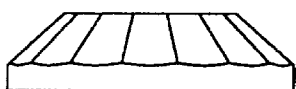

36.3

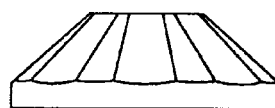

37.3



36.4



37.4



36.5

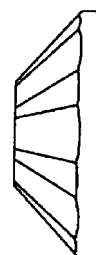

37.5

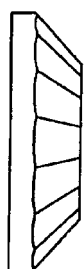

36.6



37.6

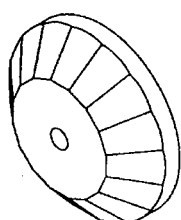

36.7

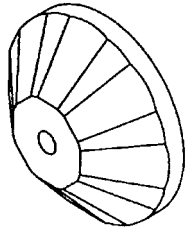

37.7



38.6

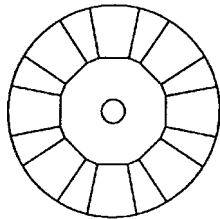

38.1

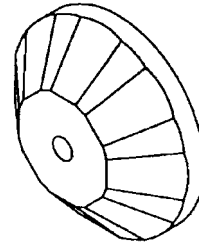

38.7

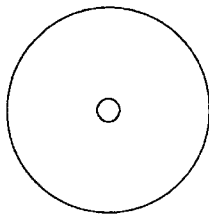

38.2

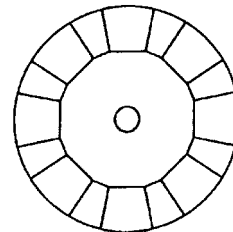

39.1



38.3

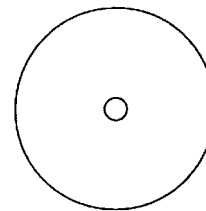

39.2

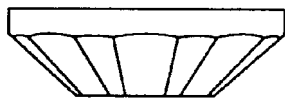

38.4



39.3

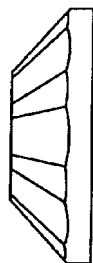

38.5



39.4



39.5



39.6

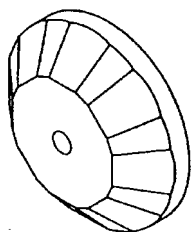

39.7

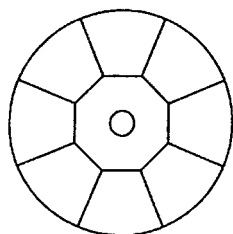

40.1

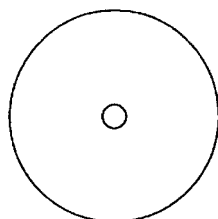

40.2

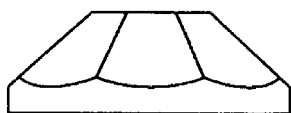

40.3



40.4

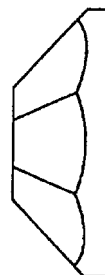

40.5



40.6

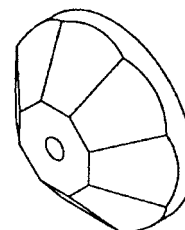

40.7

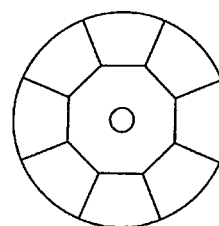

41.1

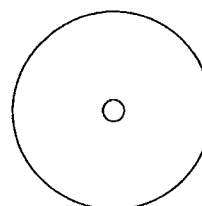

41.2

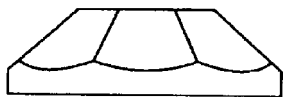

41.3

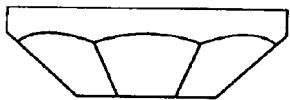

41.4



41.5



41.6

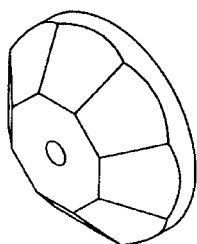

41.7

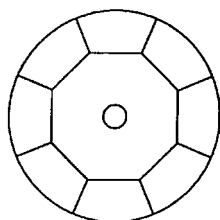

42.1

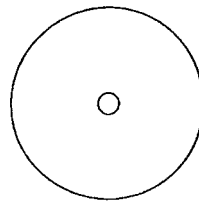

42.2



42.3



42.4



42.5



42.6

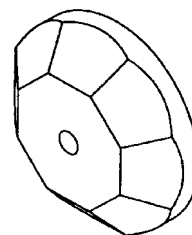

42.7

8 (51) 12/08.03

(11) 26902

(15) 4.6.2004

(18) 1.10.2008

(21) 177-2003

(22) 1.10.2003

(24) 4.6.2004

(45) 3.8.2004

(72) Klein Štefan, doc.Ing.,akad.sochár, Nitra, SK;

Maník Radovan, Ing., Banská Bystrica, SK;

(73) SlovBus, a. s., Nové Mesto nad Váhom, SK;

**(54) Autobus**

Určenie výrobku: Výrobok, v ktorom je dizajn stelesnený, je určený ako dopravný prostriedok na prepravu osôb - autobus.

(28) 1

(55)



1.1



1.2



1.3



1.4



1.5



1.6

8 (51) 12/13.10

(11) 26918

(15) 22.6.2004

(18) 31.12.2008

(21) 242-2003

(22) 31.12.2003

(24) 22.6.2004

(45) 3.8.2004

(72) Štepiča Jozef, Ing., Zvolenská Slatina, SK; Ško-

da Dušan, Ing., Zvolen, SK;

(73) WAY INDUSTRY, a. s., Krupina, SK;

(74) Regina Ivan, Ing., Košice, SK;

**(54) Vidly na guľatínu**

Určenie výrobku: Vidly na guľatínu sú prídavným zariadením najmä k šmykom riadenému nakladaču a slúžia na manipuláciu s drevnou hmotou, či už v tvare guľatiny, alebo štiepanej metrovice. Je to mechanická konštrukcia s hydraulickým ovládaním jednotlivých členov.

(28) 1

(55)

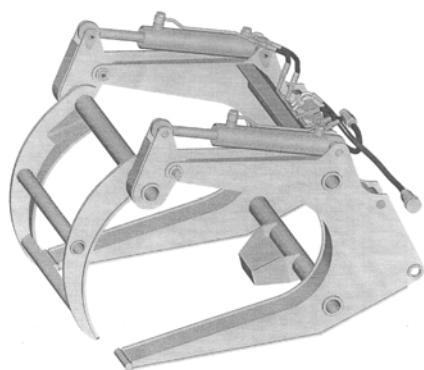

1.1

8 (51) 12/15.01

(11) 26906

(15) 4.6.2004

(18) 4.12.2008

(21) 226-2003

(22) 4.12.2003

(24) 4.6.2004

(45) 3.8.2004

(72) Kotlas Ján, Ing., Púchov, SK; Žiačík Pavol, Ing., Púchov, SK; Rypák Martin, Ing., Púchov, SK;

(73) Matador, a. s., Púchov, SK;

(74) Mrenica Jaroslav, Ing., Púchov, SK;

(54) **Dezén bežnej plochy plášt'a MP 61**

Určenie výrobku: Výrobkom, ktorým je dizajn stelesnený, je dezén bežnej plochy plášt'a, určený pre pneumatiky.

(28) 1

(55)

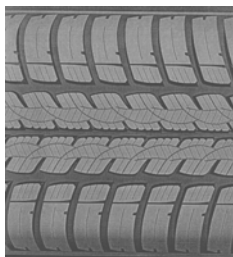

1.1

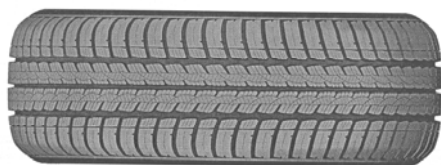

1.2



1.3

8 (51) 14/01.04

(11) 26909

(15) 18.6.2004

(18) 11.11.2008

(21) 211-2003

(22) 11.11.2003

(24) 18.6.2004

(31) 2003-16986, 2003-16987,

2003-18786, 2003-33612

(32) 12.5.2003, 12.5.2003, 27.5.2003, 6.10.2003

(33) JP, JP, JP, JP

(45) 3.8.2004

(72) Goto Teiyu, Tokyo, JP; Kanatani Masakazu, Tokyo, JP; Yasutomi Hiroshi, Tokyo, JP;

(73) Sony Computer Entertainment Inc., Tokyo 107-0062, JP;

(74) ROTT, RŮŽIČKA & GUTTMANN, v. o. s., Bratislava, SK;

(54) **Diskový zásobník, operačná a kontrolná jednotka, diaľkový ovládač**

Určenie výrobku: Dizajny č. 1 a 2

Diskový zásobník sa používa na zahrnutie diskovej pamäte, ako je počítačový program uložený na CD zahrnujúci softvér videohier a je prispôsobený na vloženie do disketovej jednotky počítača, prehrávača videohier, atď.

Dizajn č. 3

Operačná a kontrolná jednotka môže byť používaná ako prehrávač videohier, hlavná časť počítača, ktorá, napríklad, môže byť napojená na internet, CD prehrávač, DVD prehrávač, DVD rekordér, atď.

Dizajn č. 4

Diaľkový ovládač sa používa na obsluhu alebo riadenie rôznych elektronických zariadení, hlavne operačnej a kontrolnej jednotky zahrnujúcej prehrávač videohier, CD prehrávač, DVD prehrávač, DVD rekordér a hlavnú časť počítača, ktorá môže byť napojená na internet.

(28) 4

(55)

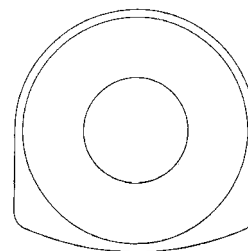

1.1

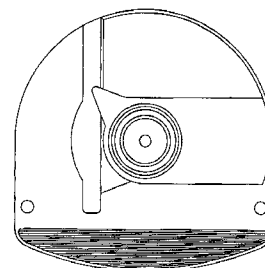

1.2





1.3



1.4



1.5

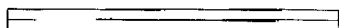

1.6

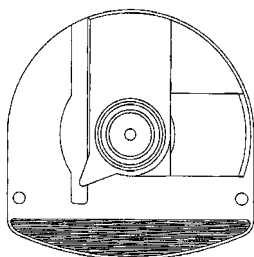

1.7

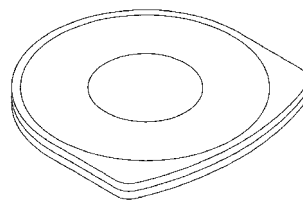

1.8

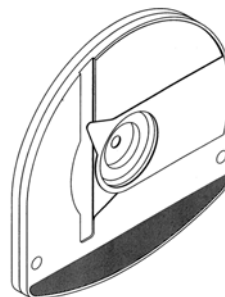

1.9

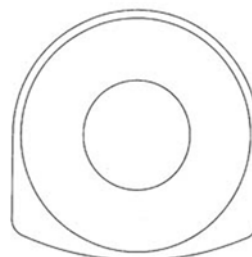

2.1

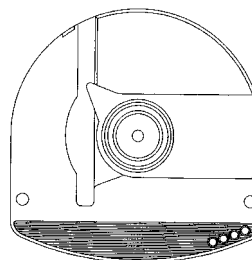

2.2



2.3



2.4

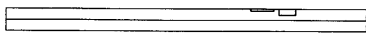

2.5

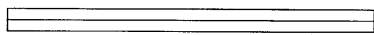

2.6

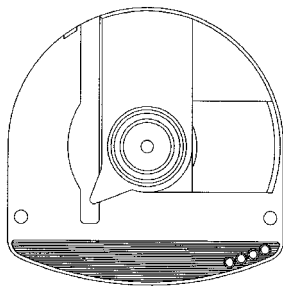

2.7

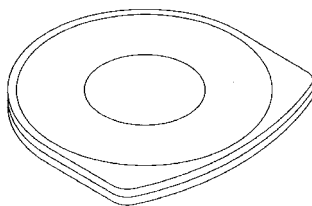

2.8

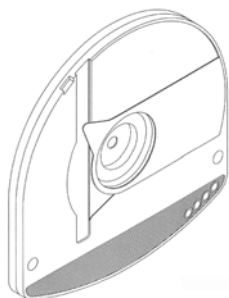

2.9

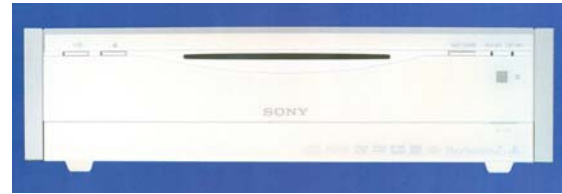

3.1

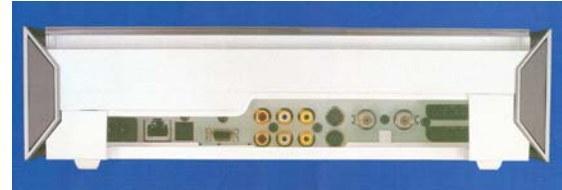

3.2



3.3



3.4



3.5

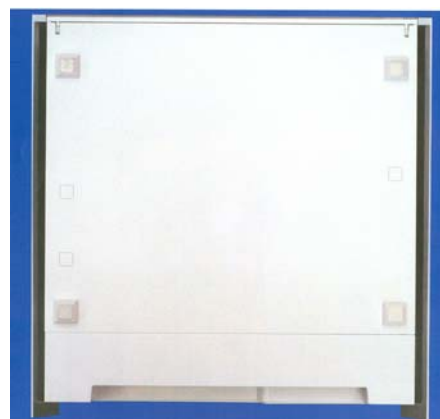

3.6



3.7



3.11



3.8

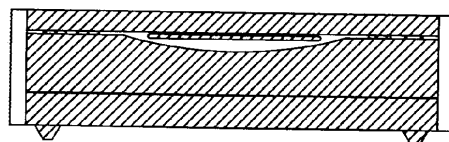

3.12

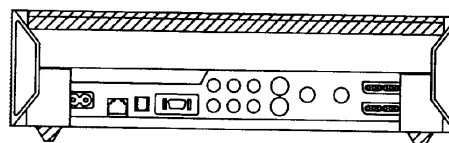

3.13



3.9

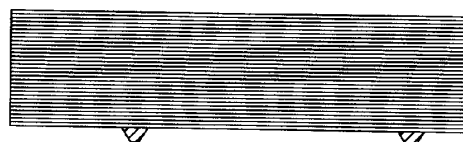

3.14



3.10

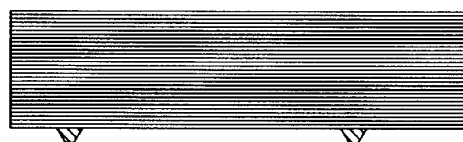

3.15

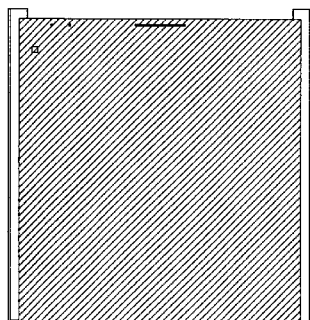

3.16

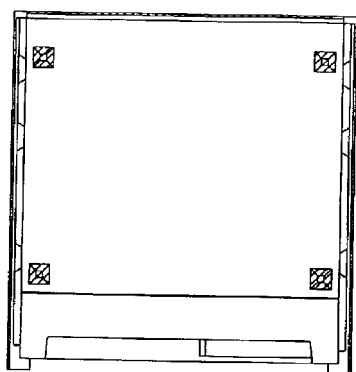

3.17

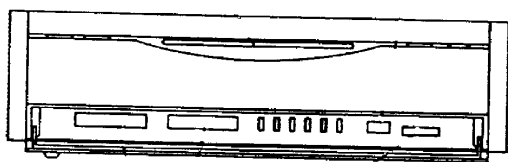

3.18

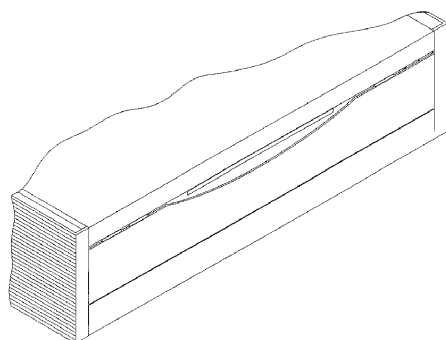

3.19

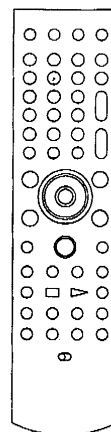

4.1

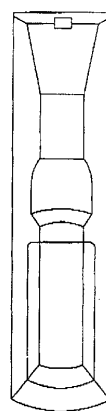

4.2



4.3



4.4

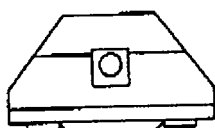

4.5



4.6

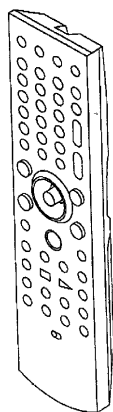

4.7

**(54) Hlavička publikácie**

Určenie výrobku: Zobrazené dizajny sú určené na periodickú alebo neperiodickú publikáciu, slúžiacu na informačné a reklamné účely.

(28) 2

(55)



1.1



2.1

**8 (51) 21/01.06****(11) 26913**

(15) 22.6.2004

(18) 17.12.2008

(21) 237-2003

(22) 17.12.2003

(24) 22.6.2004

(45) 3.8.2004

(72) Burda Zdeněk, Ing., Bratislava, SK;

(73) BURDA TOYS, s. r. o., Bratislava, SK;

(74) Beleščák Ladislav, Ing., Piešťany, SK;

**(54) Plyšová hračka**

Určenie výrobku: Výrobok, v ktorom je dizajn stelesnený alebo na ktorom je použitý, je určený najmä pre deti ako plyšová hračka na hranie, prípadne tiež na vystavenie ako dekoratívny predmet, ktorý stvárňuje postavičku chlapca.

(28) 1

(55)



1.1

**8 (51) 19/04.01****(11) 26908**

(15) 4.6.2004

(18) 12.5.2008

(21) 78-2003

(22) 12.5.2003

(24) 4.6.2004

(45) 3.8.2004

(72) Čermák Igor, Ing., Bratislava, SK;

(73) LOGI &amp; CA, s. r. o., Bratislava, SK;

(74) Šujanová Mária, Ing., Bratislava, SK;



1.2



1.3



1.4

(55)



1.1



1.2

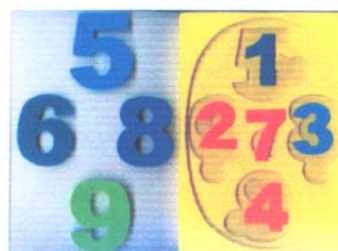

1.3

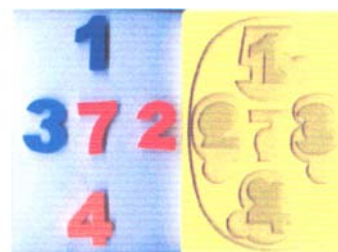

1.4

8 (51) 21/01.08

(11) 26912

(15) 22.6.2004

(18) 17.12.2008

(21) 236-2003

(22) 17.12.2003

(24) 22.6.2004

(45) 3.8.2004

(72) Burda Zdeněk, Ing., Bratislava, SK;

(73) BURDA TOYS, s. r. o., Bratislava, SK;

(74) Beleščák Ladislav, Ing., Piešťany, SK;

(54) **Detická skladačka**

Určenie výrobku: Výrobok, v ktorom je dizajn stelesnený alebo na ktorom je použitý, je určený najmä pre deti ako rôznofarebná zostava viacerých veľkostí písmen a čísiel na postupné ukladanie do zodpovedajúcich otvorov.

(28) 3



2.1

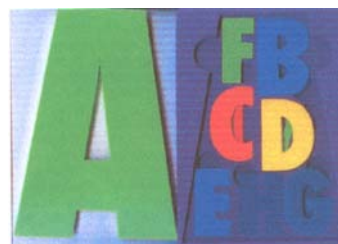

2.2





2.3



2.4



3.1

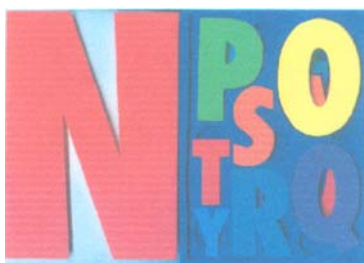

3.2

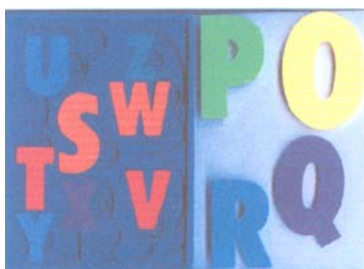

3.3



3.4

8 (51) 21/01.08

(11) 26916

(15) 22.6.2004

(18) 29.12.2008

(21) 240-2003

(22) 29.12.2003

(24) 22.6.2004

(45) 3.8.2004

(72) Burda Zdeněk, Ing., Bratislava, SK;

(73) NATEX, spol. s r. o., Bratislava, SK;

(74) Beleščák Ladislav, Ing., Piešťany, SK;

**(54) Pyramídová skladačka**

Určenie výrobku: Výrobok, v ktorom je dizajn stelesnený alebo na ktorom je použitý, je určený najmä pre deti ako rôznofarebná zostava viacerých kociek na postupné ukladanie do rôznych útvarov.

(28) 1

(55)



1.1

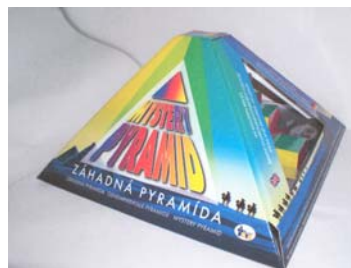

1.2



1.3



1.4

**8 (51) 24/04.02****(11) 26915**

(15) 22.6.2004

(18) 23.12.2008

(21) 239-2003

(22) 23.12.2003

(24) 22.6.2004

(45) 3.8.2004

(72) Pikner Tomáš, Ing., Zlín, CZ;

(73) ORTEX, s. r. o., Zlín, CZ;

(74) Filípek Ján, Ing., Bratislava, SK;

**(54) Ortéza na fixáciu acromioclaviculárneho kĺbu**

Určenie výrobku: Výrobky, na ktoré sa ochrana vzťahuje, sú určené pre zdravotníctvo.

(28) 1

(55)



1.1



1.2

**8 (51) 25/02.01****(11) 26903**

(15) 4.6.2004

(18) 6.10.2008

(21) 181-2003

(22) 6.10.2003

(24) 4.6.2004

(45) 3.8.2004

(72) Šulík Juraj, Stará Ľubovňa, SK; Stanek Branislav, Stará Ľubovňa, SK;

(73) Juraj Šulík - SOLIDSTAV, Stará Ľubovňa, SK;

(74) Lobodová Dagmar, Ing., Košice, SK;

**(54) Profil okenných rámov a okenných krídel**

Určenie výrobku: Profil okenných rámov a krídel podľa prihlášky dizajnu je určený na použitie pre všetky druhy presklenných okien a dverí obytných a pracovných priestorov a je vyriešením prepojenia obytných alebo pracovných priestorov s vonkajším, a to najmä prírodným prostredím.

(28) 1

(55)



1.1

**8 (51) 28/03.03****(11) 26907**

(15) 4.6.2004

(18) 4.12.2008

(21) 227-2003

(22) 4.12.2003

(24) 4.6.2004

(31) 3013046

(32) 6.6.2003

(33) GB

(45) 3.8.2004

(72) Dibnah Carl, Victoria Dock, Hull, GB; McLeish Andrew Robert, Sheffield, GB; L'Hoste Jean-Francois, Le Codray, FR;

(73) Reckitt Benckiser (UK) Limited, Slough, Berkshire, SL1 3UH, GB;

(74) Žovicová Viera, Mgr., Bratislava, SK;

**(54) Nástroj majúci holiacu hlavu bez ostria**

Určenie výrobku: Nástroj, v ktorom je dizajn stesnený alebo na ktorom bude použitý, je určený ako nástroj na holenie bez ostria v kombinácii s depilačným prípravkom na odstránenie vlasov a ochlpenia z povrchu pokožky používateľa.

(28) 3

(55)

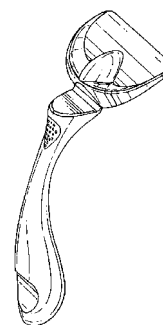

1.1



1.2



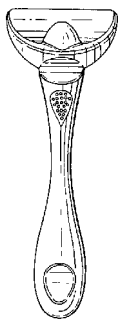

1.3

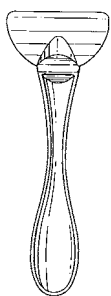

1.4

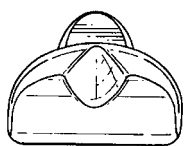

1.5

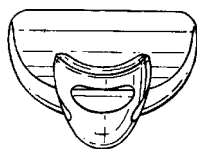

1.6

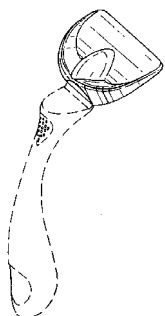

2.1



2.2

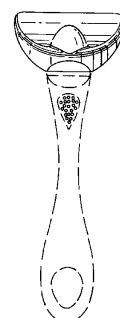

2.3

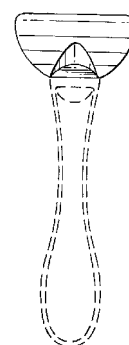

2.4

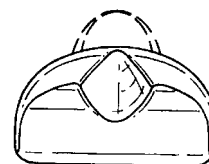

2.5

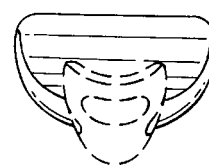

2.6

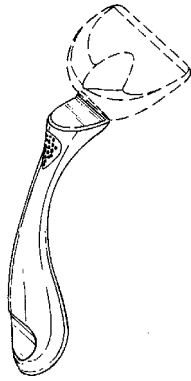

3.1

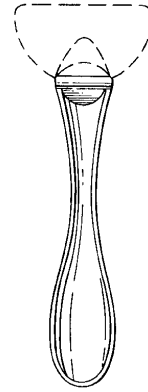

3.4



3.2

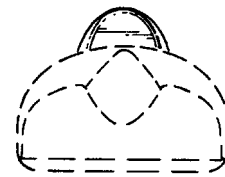

3.5

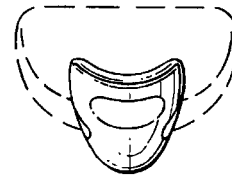

3.6

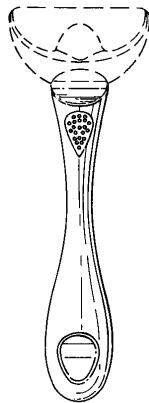

3.3

(51)	(11)	(51)	(11)	(51)	(11)	(51)	(11)
01/01.01	26911	09/01.01	26900	12/13.10	26918	21/01.08	26916
04/02.01	26914	09/01.01	26904	12/15.01	26906	21/01.08	26912
08/08.02	26910	09/01.03	26905	14/01.04	26909	24/04.02	26915
08/08.03	26917	11/01.06	26901	19/04.01	26908	25/02.01	26903
09/01.01	26899	12/08.03	26902	21/01.06	26913	28/03.03	26907

**MK4Q Zaniknuté zapísané dizajny uplynutím doby platnosti**

(11)	Dátum zániku	(11)	Dátum zániku	(11)	Dátum zániku	(11)	Dátum zániku
24517	08.11.2003	25790	19.11.2003	25807	25.11.2003	25884	26.11.2003
25774	13.11.2003	25804	12.11.2003	25808	30.11.2003	25991	02.11.2003
25775	19.11.2003	25805	12.11.2003	25811	05.11.2003		
25779	27.11.2003	25806	16.11.2003	25812	11.11.2003		

**MA4Q Zaniknuté zapísané dizajny vzdaním sa**

(11)	Dátum zániku
26527	13.05.2004

**ND4Q Predĺženie platnosti zapísaných dizajnov**

(11)	(51)	(11)	(51)	(11)	(51)	(11)	(51)
24483	12/11.04	24496	09/01.04	24602	01/01.02	25924	01/01.01
24494	09/01.04	24569	09/01.04	25407	25/99.00	25944	08/08.03
24495	09/01.04	24570	09/01.04	25906	02/02.04		

**7 (51) 01/01.01**

- (11) **25924**  
 (15) 25.1.2000  
 (18) 11.6.2009  
 (21) 132-99  
 (22) 11.6.1999  
 (73) BARILLA ALIMENTARE S.p.A., Parma, IT;  
 (54) **Sladký pekársky výrobok**

**7 (51) 08/08.03**

- (11) **25944**  
 (15) 22.2.2000  
 (18) 23.7.2009  
 (21) 153-99  
 (22) 23.7.1999  
 (73) ZEDEL (société' anonyme), 38920 Crolles, FR;  
 (54) **Blokováci prvok**

**7 (51) 01/01.02**

- (11) **24602**  
 (15) 5.6.1995  
 (18) 28.6.2009  
 (21) 167-94  
 (22) 28.6.1994  
 (73) UNILEVER NV, AL Rotterdam, NL;  
 (54) **Zmrzlina**

**7 (51) 09/01.04**

- (11) **24570**  
 (15) 17.5.1995  
 (18) 13.6.2009  
 (21) 139-94  
 (22) 13.6.1994  
 (73) UNILEVER NV, AL Rotterdam, NL;  
 (54) **Ovládač uzáveru**

**7 (51) 02/02.04, 02/02.01**

- (11) **25906**  
 (15) 12.1.2000  
 (18) 7.5.2009  
 (21) 96-99  
 (22) 7.5.1999  
 (73) HANTEX, spol. s r. o., Handlová, SK;  
 (54) **Košele pre OZ SR**

**7 (51) 09/01.04**

- (11) **24495**  
 (15) 16.3.1995  
 (18) 13.6.2009  
 (21) 141-94  
 (22) 13.6.1994  
 (73) UNILEVER NV, AL Rotterdam, NL;  
 (54) **Fľaša**

**7 (51) 09/01.04**  
**(11) 24569**  
 (15) 17.5.1995  
 (18) 13.6.2009  
 (21) 138-94  
 (22) 13.6.1994  
 (73) UNILEVER NV, AL Rotterdam, NL;  
**(54) Ovládač uzáveru**

**7 (51) 12/11.04**  
**(11) 24483**  
 (15) 8.3.1995  
 (18) 30.5.2009  
 (21) 126-94  
 (22) 30.5.1994  
 (73) Hota Petr Ing., Ostrava - Poruba, CZ;  
**(54) Detská sedačka**

**7 (51) 09/01.04**  
**(11) 24494**  
 (15) 16.3.1995  
 (18) 13.6.2009  
 (21) 140-94  
 (22) 13.6.1994  
 (73) UNILEVER NV, AL Rotterdam, NL;  
**(54) Fľaša**

**7 (51) 25/99.00**  
**(11) 25407**  
 (15) 16.12.1997  
 (18) 17.6.2009  
 (21) 152-94  
 (22) 17.6.1994  
 (73) Plastika, a. s., Kroměříž, CZ;  
**(54) Cestné smerové stĺpiky**

**7 (51) 09/01.04, 09/07.00**  
**(11) 24496**  
 (15) 16.3.1995  
 (18) 13.6.2009  
 (21) 142-94  
 (22) 13.6.1994  
 (73) UNILEVER NV, AL Rotterdam, NL;  
**(54) Ovládač uzáveru**

(51)	(11)	(51)	(11)	(51)	(11)	(51)	(11)
01/01.01	25924	08/08.03	25944	09/01.04	24570	12/11.04	24483
01/01.02	24602	09/01.04	24495	09/01.04	24494	25/99.00	25407
02/02.04	25906	09/01.04	24569	09/01.04	24496		

## QB4Q

## Licenčné zmluvy registrované

**(11) 26339**  
 (21) 29-2001  
 (58) 2.6.2004  
 (73) BLIZNIAK Peter, Ing., Košťany nad Turcom, SK;  
 Nadobúdateľ: TURČAN DELTA, s. r. o., Košťany nad Turcom, SK;  
 Druh licencie: zmluvná nevýlučná  
 Dátum uzavretia licenčnej zmluvy: 15.4.2003  
 Dátum účinnosti voči tretím osobám: 2.6.2004

**(11) 26856**  
 (21) 192-2003  
 (58) 2.6.2004  
 (73) Blizniak Peter, Ing., Košťany nad Turcom, SK;  
 Nadobúdateľ: TURČAN DELTA, s. r. o., Košťany nad Turcom, SK;  
 Druh licencie: zmluvná nevýlučná  
 Dátum uzavretia licenčnej zmluvy: 30.3.2004  
 Dátum účinnosti voči tretím osobám: 2.6.2004