

ČASŤ

DIZAJNY

Číselné INID - kódy na označovanie bibliografických údajov (Standard WIPO ST. 80)

(11)	Číslo zapísaného dizajnu	(51)	Medzinárodné triedenie dizajnov
(15)	Dátum zápisu/predĺženia platnosti	(54)	Názov dizajnu
(18)	Predpokladaný dátum uplynutia platnosti zápisu/-predĺženia platnosti	(55)	Vyobrazenie dizajnu/vyobrazenie dizajnu po čiastočnom výmaze
(21)	Číslo prihlášky	(58)	Dátum záznamu v registri, napr. zmeny mena, zániku, výmazu a pod.
(22)	Dátum podania prihlášky	(62)	Číslo pôvodnej prihlášky v prípade vylúčenej prihlášky
(28)	Počet dizajnov	(72)	Meno pôvodcu (-ov)
(31)	Číslo prioritnej prihlášky	(73)	Meno (názov) majiteľa (-ov)
(32)	Dátum podania prioritnej prihlášky	(74)	Meno (názov) zástupcu (-ov)
(33)	Krajina alebo regionálna organizácia priority	(78)	Meno (názov) nového majiteľa (-ov) po prevode alebo prechode
(45)	Dátum sprístupnenia zapísaného dizajnu		
(46)	Dátum uplynutia odkladu zverejnenia		

Poznámka:

Číslo uvádzané pred kódom (51) znamená verziu Medzinárodného triedenia dizajnov.

Kódy na označovanie záhlaví oznámení publikovaných vo Vestníku ÚPV SR (Standard WIPO ST. 17)

FG4Q	Zapísané dizajny
FG4Q	Zapísané dizajny s odloženým zverejnením
FG4Q	Zverejnené zapísané dizajny po uplynutí doby odkladu zverejnenia
MA4Q	Zaniknuté zapísané dizajny vzdáním sa
MA4Q	Čiastočne zaniknuté zapísané dizajny vzdáním sa
MC4Q	Vymazané zapísané dizajny
MG4Q	Čiastočne vymazané zapísané dizajny
MK4Q	Zaniknuté zapísané dizajny uplynutím doby platnosti
ND4Q	Predĺženie platnosti zapísaných dizajnov
PC4Q	Prevody a prechody práv
PD4Q	Zmeny dispozičných práv na zapísané dizajny (zálohy)
PD4Q	Zmeny dispozičných práv na zapísané dizajny (ukončenie zálohov)
QB4Q	Licenčné zmluvy registrované
QC4Q	Ukončenie platnosti licenčných zmlúv
RL4Q	Odhätie ochrany a prepis majiteľa dizajnu (na základe rozhodnutia súdu)
TA4Q	Doplnenie pôvodcu (-ov)
TB4Q	Opravy mien
TC4Q	Zmeny mien
TD4Q	Opravy adries
TE4Q	Zmeny adries
TF4Q	Opravy dátumov
TG4Q	Opravy zatriedenia podľa Medzinárodného triedenia dizajnov
TH4Q	Opravy chýb alebo zmeny všeobecne
TK4Q	Opravy tlačových chýb vo Vestníku ÚPV SR

FG4Q

Zapísané dizajny

(11)	(51)	(11)	(51)	(11)	(51)	(11)	(51)
27846	25/03.01	27850	12/16.06	27854	21/01.10	27857	11/99.00
27847	08/06.00	27851	26/06.00	27855	06/99.00	27858	06/03.02
27848	26/06.00	27852	12/16.06	27856	06/03.02	27859	05/05.00
27849	12/08.04	27853	20/03.03				

9 (51) 05/05.00, 05/06.00

(11) 27859

(15) 24.9.2012

(18) 5.1.2017

(21) 5001-2012

(22) 5.1.2012

(72) Furák Poórová Petra, Mgr., art., Bratislava, SK;

(73) Furák Poórová Petra, Mgr., art., Bratislava, SK;

(74) ROTT, RŮŽIČKA & GUTTMANN, Bratislava, SK;

(54) Povrchové vzory

Určenie výrobku:

Výrobky, na ktorých budú dizajny stelesnené, sú textilné materiály, papierové výrobky, obaly.

(28) 2

(55)



1.1

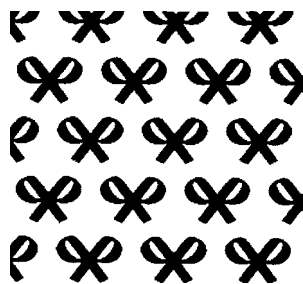

2.1

(54) Bazový stolík

Určenie výrobku:

Výrobok, v ktorom je dizajn stelesnený, je bazový stolík, ktorý je vo svojej podstate nábytkom slúžiacim na dočasné alebo trvalé ukládanie vecí na vodorovnú plochu, slúžiaci na stolovanie, vykonávanie administratívnych pracovných úkonov, ako aj iné činnosti vykonávajúce najmä v sede. Prípadne poslúži len ako estetický doplnok miestnosti. Základom tohto nábytku je pevná vodorovná voľne, ale symetricky uložená plocha (stolová doska z hrubého skla) na trojnožke vyrobenej z bazového dreva. Bazový stolík by mohol nájsť skvelé uplatnenie a svojim dizajnom spríjemniť priestory v domácnostiach (host'ovské izby, obývačky, terasy, lodžie) v čajovníach a kaviarňach, prípadne v pracovných priestoroch firiem.

(28) 1

(55)



1.1



1.2

9 (51) 06/03.02

(11) 27858

(15) 24.9.2012

(18) 10.2.2017

(21) 6-2012

(22) 10.2.2012

(72) Čulík Martin, Ing., PhD., Sása, SK; Danihelová Anna, doc. RNDr., PhD., Zvolen, SK;

(73) Čulík Martin, Ing., PhD., Sása, SK; Danihelová Anna, doc. RNDr., PhD., Zvolen, SK; Technická univerzita vo Zvolene, Zvolen, SK;

9 (51) 06/03.02

(11) 27856

(15) 24.9.2012

(18) 10.2.2017

(21) 4-2012

(22) 10.2.2012

(72) Čulík Martin, Ing., PhD., Sása, SK; Chovan Miroslav, Ing. ArtD., Zvolen, SK; Danihelová Anna, doc. RNDr., PhD., Zvolen, SK; Tončíková Zuzana, Ing., Banská Bystrica, SK; Němec Miroslav, Mgr., PhD., Zvolen, SK; Košúth Stanislav, Ing., PhD., Zvolen, SK; Očenáš Andrej, Banská Bystrica, SK;

(73) Čulík Martin, Ing., PhD., Sása, SK; Chovan Miroslav, Ing. ArtD., Zvolen, SK; Danihelová Anna, doc. RNDr., PhD., Zvolen, SK; Tončíková Zuzana, Ing., Banská Bystrica, SK; Němec Miroslav, Mgr., PhD., Zvolen, SK; Košúth Stanislav, Ing., PhD., Zvolen, SK; Očenáš Andrej, Banská Bystrica, SK; Technická univerzita vo Zvolene, Zvolen, SK;

(54) **Music Coffee Table**

Určenie výrobku:

Výrobok, v ktorom je dizajn stelesnený, je Music Coffee Table, ako "hudobný xylofónový stôl", ktorý môže nájsť skvelé uplatnenie v bytových priestoroch (obývačka, detská izba, hosťovská izba), resp. v reštauračných prevádzkach (kaviareň, čajovňa, cukráreň), prípadne v hosťovských priestoroch firiem.

(28) 1

(55)

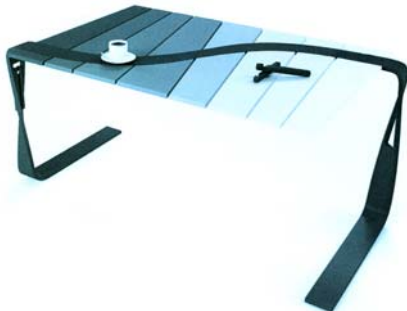

1.1



1.2

9 (51) 06/99.00

(11) 27855

(15) 24.9.2012

(18) 10.2.2017

(21) 3-2012

(22) 10.2.2012

(72) Čulík Martin, Ing., PhD., Sása, SK; Chovan Miroslav, Ing. ArtD., Zvolen, SK; Danihelová Anna, doc. RNDr., PhD., Zvolen, SK; Tončíková Zuzana, Ing., Banská Bystrica, SK; Němec Miroslav, Mgr., PhD., Zvolen, SK; Košúth Stanislav, Ing., PhD., Zvolen, SK; Mikulík Andrej, Revúca, SK; Močári Michal, Banská Bystrica, SK;

(73) Čulík Martin, Ing., PhD., Sása, SK; Chovan Miroslav, Ing. ArtD., Zvolen, SK; Danihelová Anna, doc. RNDr., PhD., Zvolen, SK; Tončíková Zuzana, Ing., Banská Bystrica, SK; Němec Miroslav, Mgr., PhD., Zvolen, SK; Košúth Stanislav, Ing., PhD., Zvolen, SK; Mikulík Andrej, Revúca, SK; Močári Michal, Banská Bystrica, SK; Technická univerzita vo Zvolene, Zvolen, SK;

(54) **Silence Globe**

Určenie výrobku:

Výrobok Silence Globe ako "tichý glóbus", v ktorom je dizajn stelesnený, je možné využiť na oddych a regeneráciu v bytových priestoroch, resp. v pracovných priestoroch firiem, kde potrebujeme odfiltrovať okolitý hluk a zároveň máme potrebu oddýchnuť si.

(28) 1

(55)

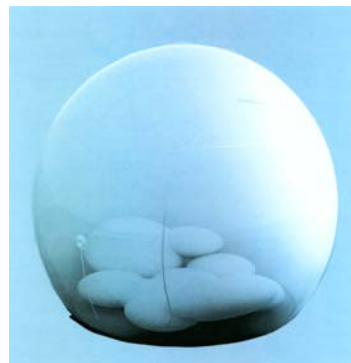

1.1



1.2

9 (51) 08/06.00

(11) 27847

(15) 4.9.2012

(18) 19.4.2017

(21) 5008-2012

(22) 19.4.2012

(31) CZ PVZ 2011-38862, CZ PVZ 2012-39010,
CZ PVZ 2012-39021

(32) 23.11.2011, 4.4.2012, 16.4.2012

(33) CZ, CZ, CZ

(72) Ulich Roman, Praha, CZ;

(73) Material & Technology s.r.o., Nové Město nad
Metují, CZ;

(74) Bachratá Magdaléna, Mgr., Bratislava, SK;

(54) Kľučka a kľučka s rozetou

Určenie výrobku:

Výrobok - kľučka a kľučka s rozetou - slúži na
otváranie a zatváranie, najmä dverí.

(28) 16

(55)

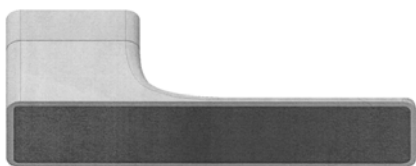

1.1

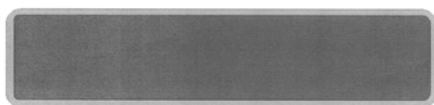

1.2

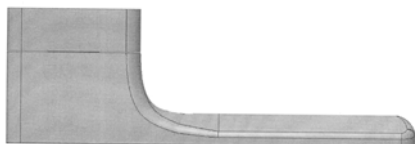

1.3

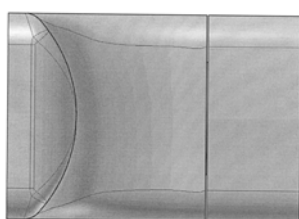

1.4

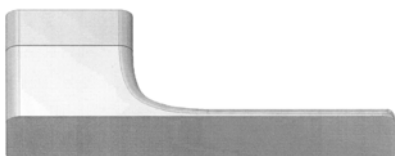

2.1



2.2

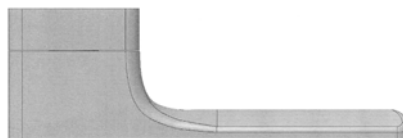

2.3

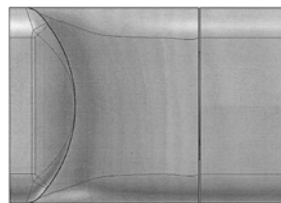

2.4



3.1



3.2



3.3

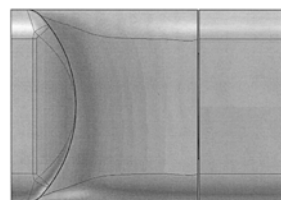

3.4



4.1



4.2

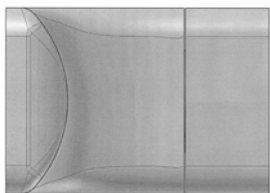

4.3

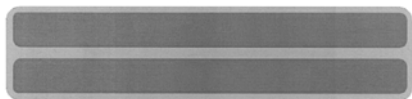

5.1



5.2

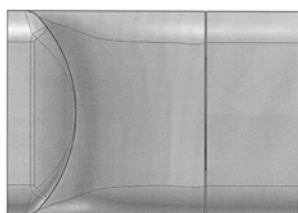

5.3



6.1

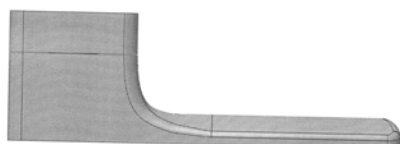

6.2

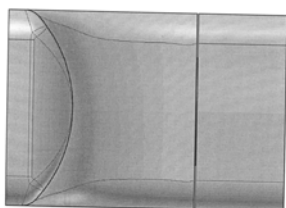

6.3

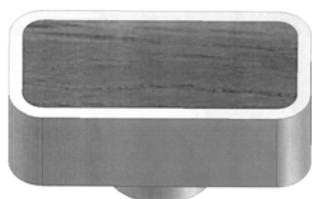

7.1



7.2

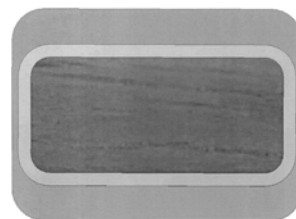

8.1

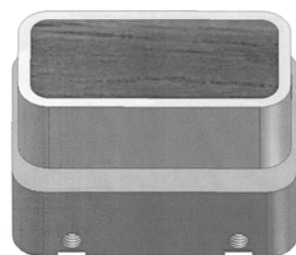

8.2



9.1



9.2

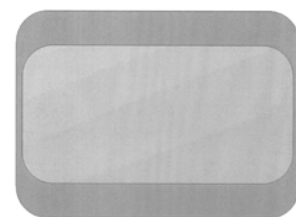

10.1

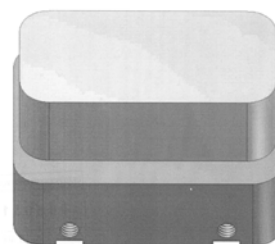

10.2

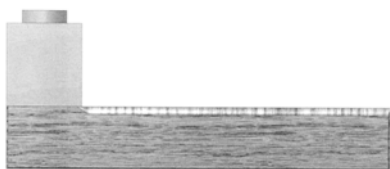

11.1



11.2



11.3



11.4

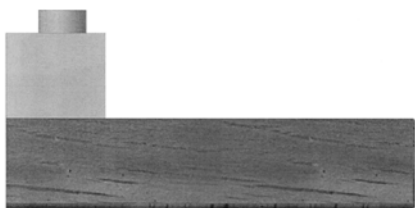

12.1



12.2

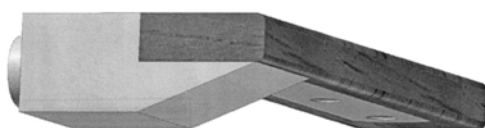

12.3



13.1

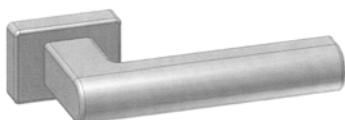

13.2



13.3



14.1

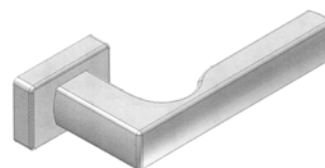

14.2

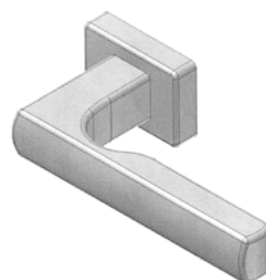

14.3



15.1

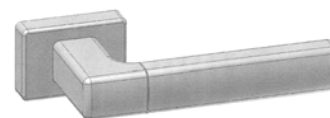

15.2



15.3



16.1

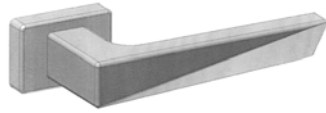

16.2



16.3



16.4

9 (51) 11/99.00

(11) 27857

(15) 24.9.2012

(18) 10.2.2017

(21) 5-2012

(22) 10.2.2012

(72) Čulík Martin, Ing., PhD., Sása, SK; Chovan Miroslav, Ing. ArtD., Zvolen, SK; Danihelová Anna, doc. RNDr., PhD., Zvolen, SK; Tončíková Zuzana, Ing., Banská Bystrica, SK; Němec Miroslav, Mgr., PhD., Zvolen, SK; Košúth Stanislav, Ing., PhD., Zvolen, SK; Štefkovič Ján, Jacovce, SK;

(73) Čulík Martin, Ing., PhD., Sása, SK; Chovan Miroslav, Ing. ArtD., Zvolen, SK; Danihelová Anna, doc. RNDr., PhD., Zvolen, SK; Tončíková Zuzana, Ing., Banská Bystrica, SK; Němec Miroslav, Mgr., PhD., Zvolen, SK; Košúth Stanislav, Ing., PhD., Zvolen, SK; Štefkovič Ján, Jacovce, SK; Technická univerzita vo Zvolene, Zvolen, SK;

(54) **Talltale Sound Wind Direction**

Určenie výrobku:

Výrobok, v ktorom je dizajn stelesnený, je Talltale Sound Wind Direction ako objekt a zároveň "prirodzený zvukový hlásič smeru a sily vetra", ktorý je možné inštalovať v exteriéri (ulica, námestie, park, pešia zóna a iné verejné priestory). Odporúča sa umiestnenie v otvorených priestranstvách.

(28) 1

(55)

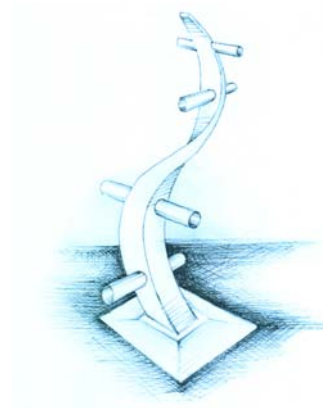

1.1



1.2

9 (51) 12/08.04, 12/16.04, 12/16.06

(11) 27849

(15) 4.9.2012

(18) 2.5.2017

(21) 5013-2012

(22) 2.5.2012

(31) 002010538-0001, 002010538-0002

(32) 19.3.2012, 19.3.2012

(33) EM, EM

(73) DAF Trucks N.V., TW EINDHOVEN, NL;

(74) Fajnorová Mária, Ing., Bratislava, SK;

(54) **Vozidlá a časti a príslušenstvo vozidiel**

Určenie výrobku:

Výrobky, ktorými sú tieto dizajny stelesnené, sú nákladnými automobilmi alebo sú súčasťami týchto nákladných automobilov a sú určené na ich zostavenie.

(28) 30

(55)



1.1



1.2



2.2



1.3



2.3



2.4



1.4



2.5

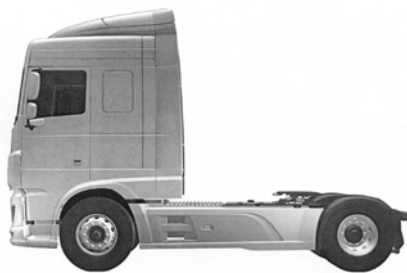

1.5

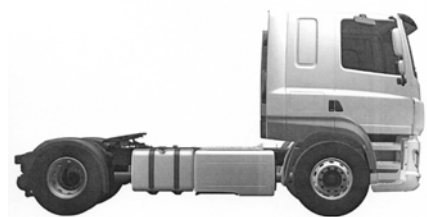

3.1

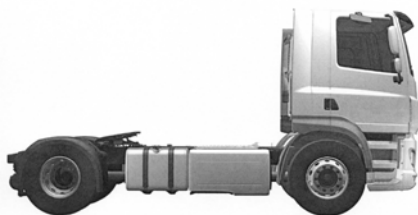

2.1



3.2



3.3



4.4



3.4



4.5



3.5

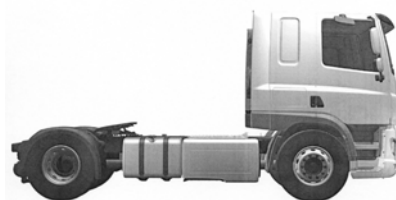

5.1

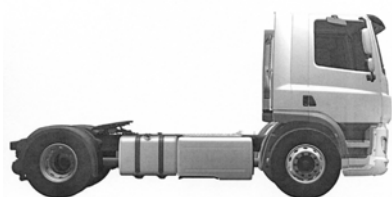

4.1



5.2



4.2



5.3



4.3



5.4



5.5



7.1



6.1



7.2



6.2



7.3



6.3



8.1



6.4



8.2



6.5



8.3



9.1



9.2



9.3

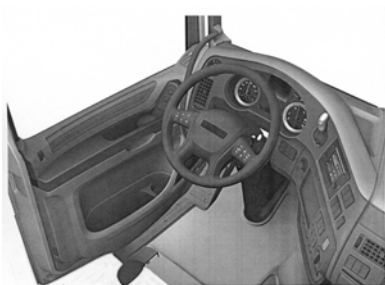

10.1

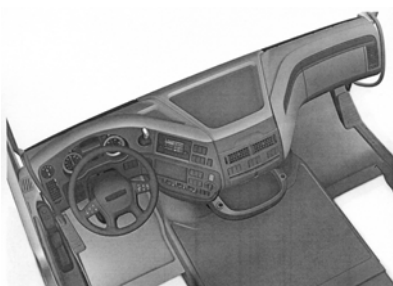

10.2

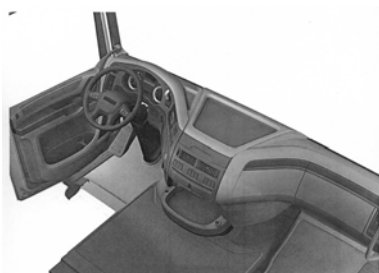

10.3

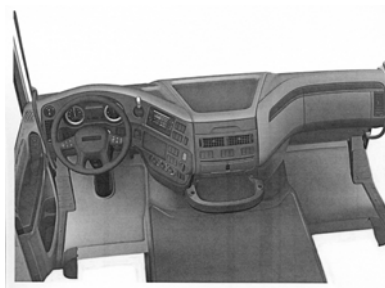

10.4

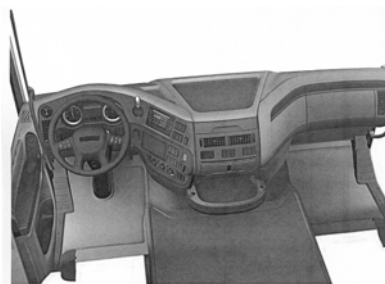

10.5



10.6



11.1



11.2

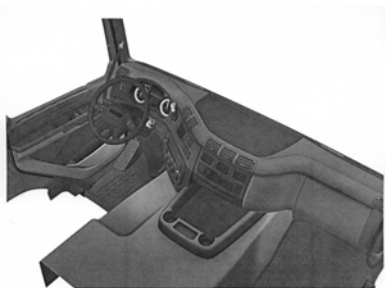

11.3



12.1

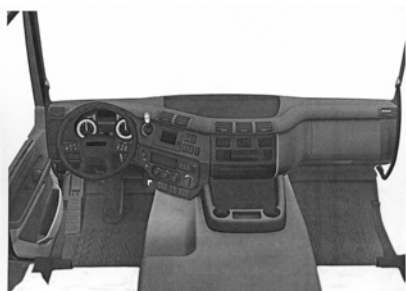

11.4



12.2

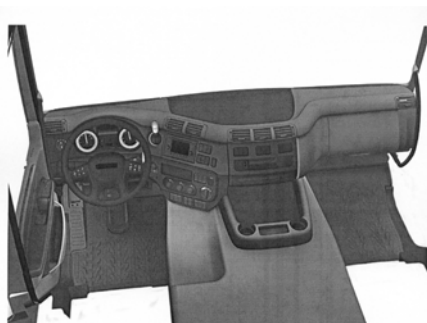

11.5

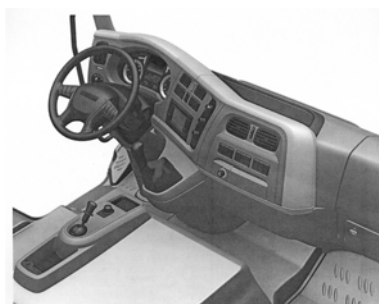

12.3



11.6



12.4



11.7



12.5



12.6

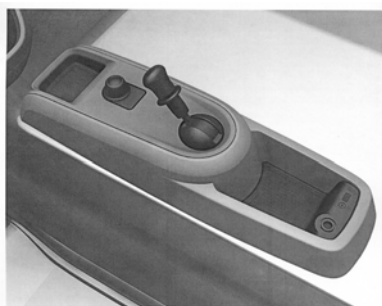

12.7

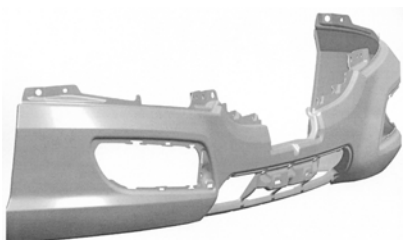

13.1



13.2

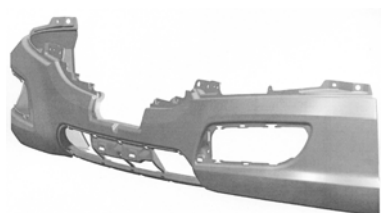

13.3

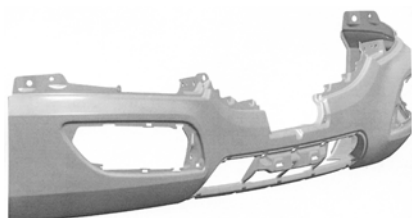

14.1



14.2

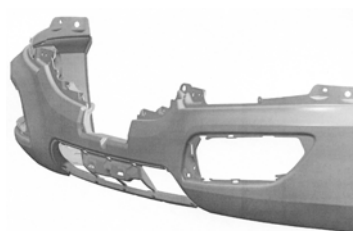

14.3

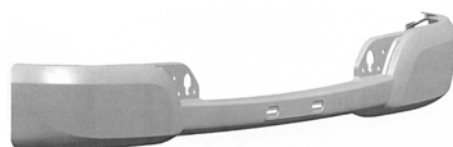

15.1



15.2



15.3

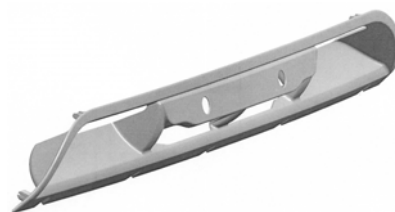

16.1



16.2



16.3

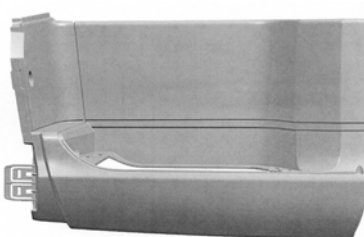

17.1



17.2

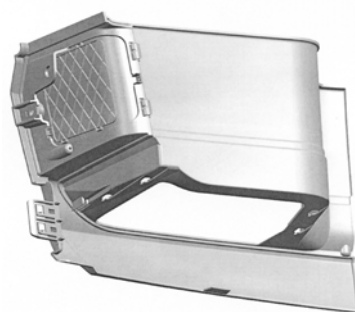

18.3



17.3

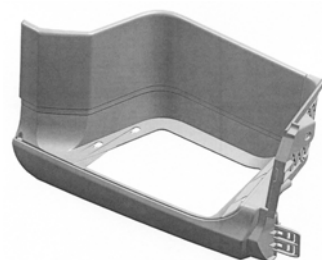

18.4



17.4



19.1

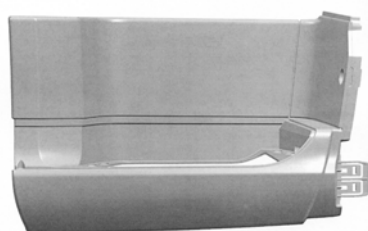

18.1



19.2

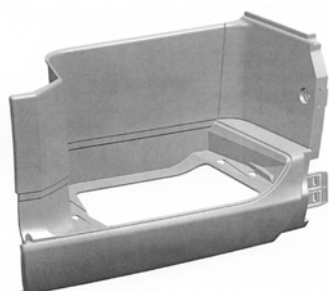

18.2

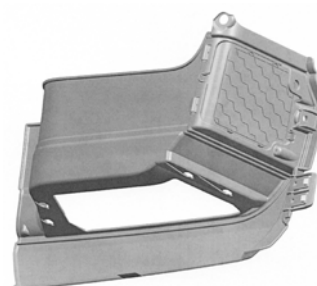

19.3



19.4

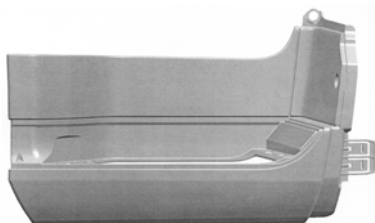

20.1

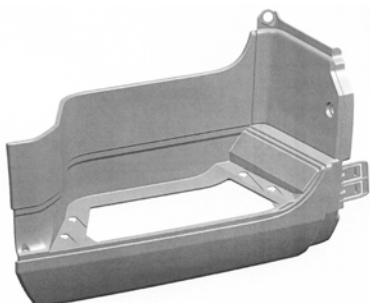

20.2

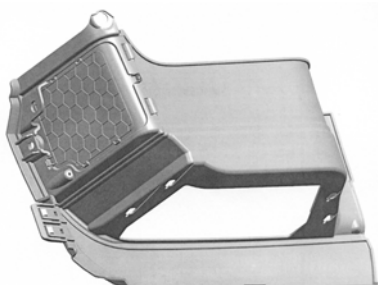

20.3

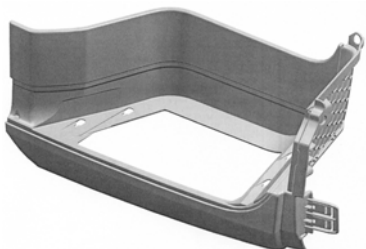

20.4



21.1



21.2



21.3



22.1

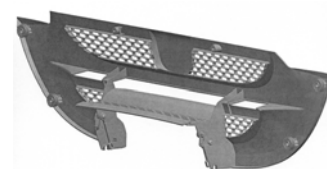

22.2

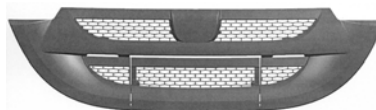

22.3



23.1

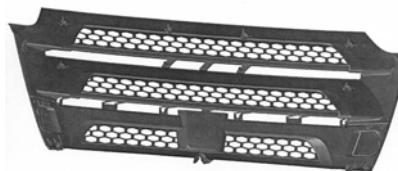

23.2

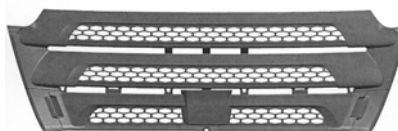

23.3

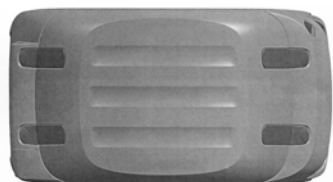

24.1



24.2



24.3

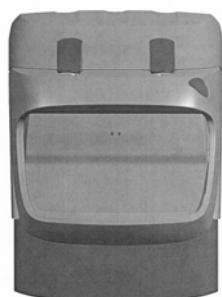

24.4



24.5



24.6



24.7



25.1

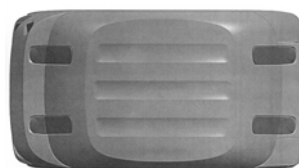

25.2



25.3



25.4

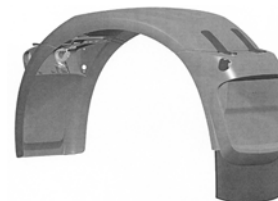

25.5

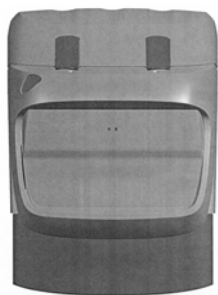

25.6



27.1



25.7



27.2



26.1

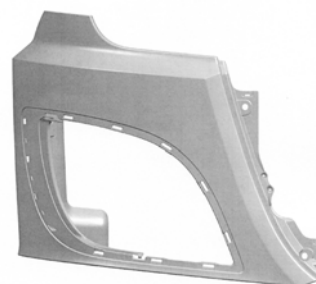

27.3



26.2



28.1



26.3



28.2



28.3



29.1

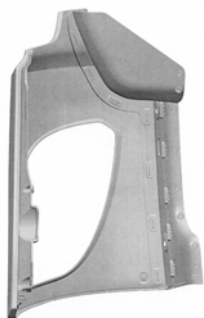

29.2

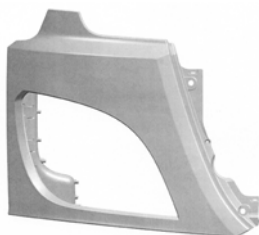

29.3



30.1



30.2



30.3

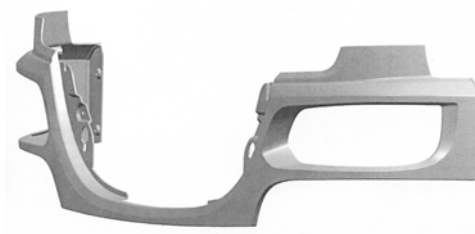

30.4

9 (51) 12/16.06**(11) 27852**

(15) 4.9.2012

(18) 27.4.2017

(21) 29-2012

(22) 27.4.2012

(31) SE 2011/0403

(32) 9.11.2011

(33) SE

(72) Lanz Andreas, Stockholm, SE; Carreras-Castro Xavier, Lidingö, SE;

(73) SCANIA CV AB, Södertälje, SE;

(74) Bačík Kvetoslav, Ing., Nová Dubnica, SK;

(54) Bočný plášť nárazníka

Určenie výrobku:

Výrobok, v ktorom je dizajn stelesnený, je určený na bočné oplášťovanie nárazníka vozidla.

(28) 1

(55)

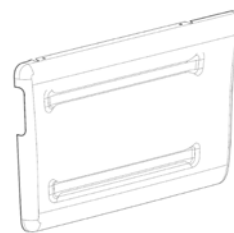

1.1

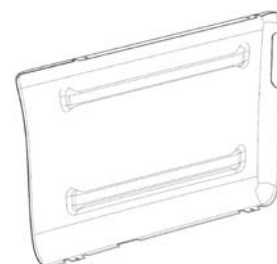

1.2

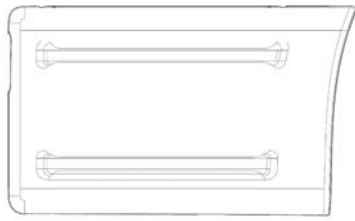

1.3

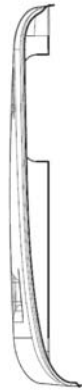

1.4

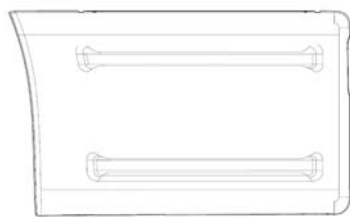

1.5



1.6



1.7



1.8

9 (51) 12/16.06, 12/16.08, 12/16.11

(11) 27850

(15) 4.9.2012

(18) 7.5.2017

(21) 5014-2012

(22) 7.5.2012

(31) PVZ 2011-38882

(32) 13.12.2011

(33) CZ

(72) Kabaň Jozef, Mladá Boleslav, CZ;

(73) ŠKODA AUTO a. s., Mladá Boleslav, CZ;

(74) ROTT, RŮŽIČKA & GUTTMANN, Bratislava, SK;

(54) **Súčasť automobilu**

Určenie výrobku:

Výrobky, v ktorých budú dizajny stelesnené, sú vybrané súčasti karosérie automobilu.

(28) 12

(55)



1.1

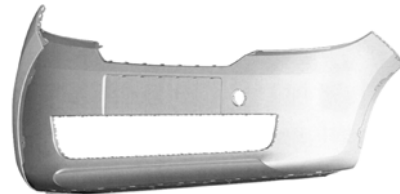

1.2



1.3



1.4



1.5



1.6



1.7



2.7

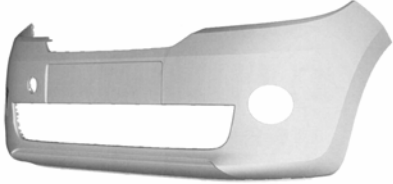

2.1

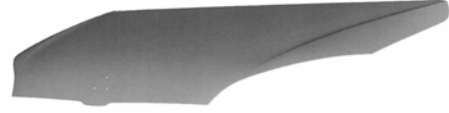

3.1

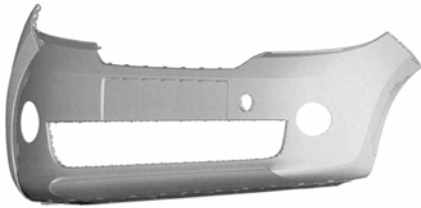

2.2



3.2

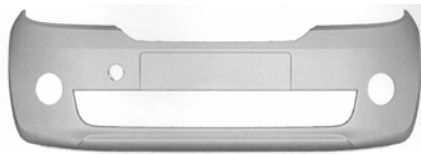

2.3



3.3



2.4



3.4



2.5



3.5



2.6



4.1

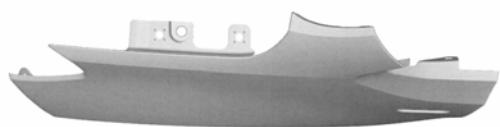

4.2

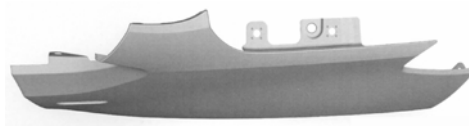

5.2



4.3



5.3



4.4



5.4



4.5



5.5



5.1

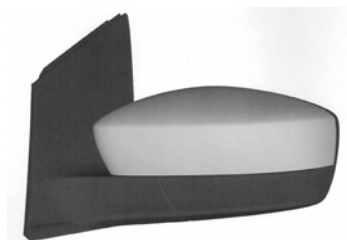

6.1

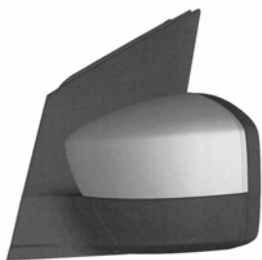

6.2

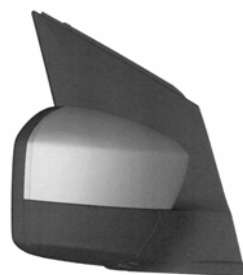

7.2



6.3



7.3



6.4



7.4



6.5



7.5

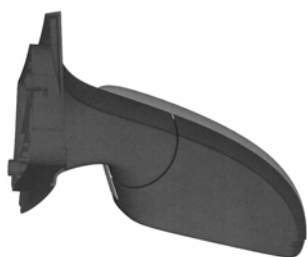

6.6



7.6

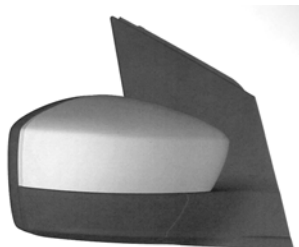

7.1

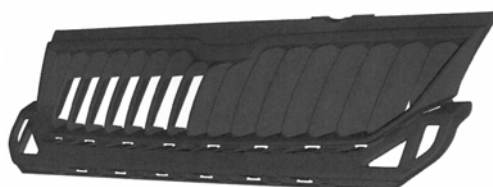

8.1

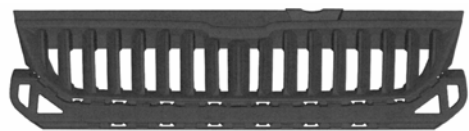

8.2



8.3



8.4

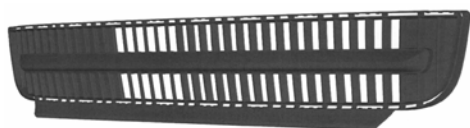

9.1

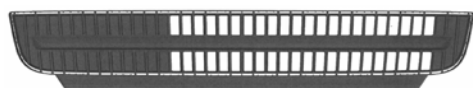

9.2



9.3



9.4



10.1



10.2



10.3



10.4



10.5



11.1



11.2



11.3

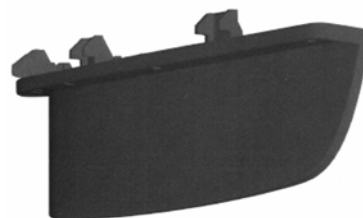

11.4

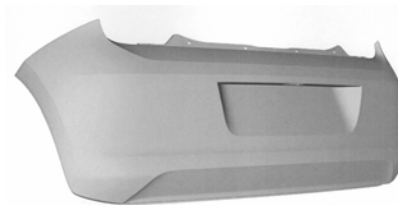

12.1

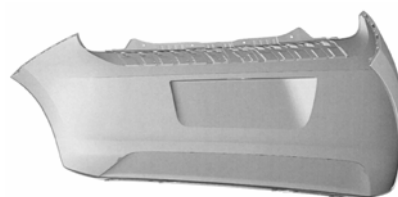

12.2



12.3



12.4



12.5



12.6



12.7

- 9 (51) 20/03.03
 (11) 27853
 (15) 21.9.2012
 (18) 2.2.2017
 (21) 1-2012
 (22) 2.2.2012
 (73) Big Screen Media, s. r. o., Košice, SK;
 (54) **NAJLEPŠIE V MESTE**

Určenie výrobku:

Výrobok, v ktorom je dizajn stelesnený, je reklamný nosič - veľkoplošná obrazovka zostavená z niekoľkých full HD obrazoviek, ktoré vytvárajú videostenu (digital signage system-Video-wall).

(28) 1

(55)



1.1



1.2

- 9 (51) 21/01.10
 (11) 27854
 (15) 24.9.2012
 (18) 10.2.2017
 (21) 2-2012
 (22) 10.2.2012
 (72) Čulík Martin, Ing., PhD., Sása, SK; Chovan Miroslav, Ing. ArtD., Zvolen, SK; Danihelová Anna, doc. RNDr., PhD., Zvolen, SK; Tončíková Zuzana, Ing., Banská Bystrica, SK; Němec Miroslav, Mgr., PhD., Zvolen, SK; Košúth Stanislav, Ing., PhD., Zvolen, SK; Kliment Lukáš, Rimavské Zalužany, SK;
 (73) Čulík Martin, Ing., PhD., Sása, SK; Chovan Miroslav, Ing. ArtD., Zvolen, SK; Danihelová Anna, doc. RNDr., PhD., Zvolen, SK; Tončíková Zuzana, Ing., Banská Bystrica, SK; Němec Miroslav, Mgr., PhD., Zvolen, SK; Košúth Stanislav, Ing., PhD., Zvolen, SK; Kliment Lukáš, Rimavské Zalužany, SK; Technická univerzita vo Zvolene, Zvolen, SK;
 (54) **Soundcard - Sound Toy**
 Určenie výrobku:
 Výrobok, v ktorom je dizajn stelesnený, je Soundcard - Sound Toy ako "zvuková hračka", určená na hru, zábavu a relax pre deti, mládež a dospelých.
 (28) 1
 (55)



1.1

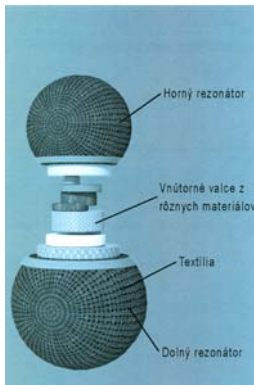

1.2

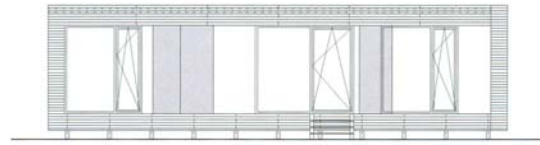

1.3



1.4

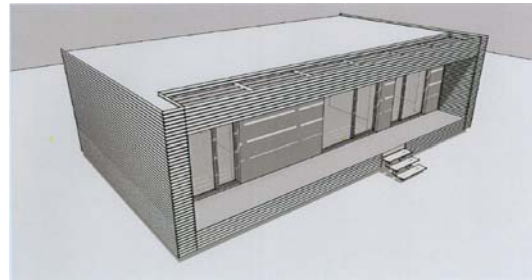

1.5

9 (51) 25/03.01

(11) 27846

(15) 4.9.2012

(18) 16.4.2017

(21) 5006-2012

(22) 16.4.2012

(72) Holeščáková Vanda, Ing. arch., Bratislava, SK;
Husárová Voleková Katarína, Ing., Bratislava, SK;

(73) Holeščáková Vanda, Ing. arch., Bratislava, SK;
Husárová Voleková Katarína, Ing., Bratislava, SK;

(54) Montovaná drevostavba obytného domu využitelná aj ako chata, predajný a výstavný stánok

Určenie výrobku:

Výrobok, v ktorom je stelesnený dizajn, je obytný dom na báze drevostavby, vyhotovený z dielcov vo výrobní hali a montovaný na pozemku, môže slúžiť aj ako chata alebo predajný a výstavný stánok.

(28) 1

(55)



1.1



1.2

9 (51) 26/06.00

(11) 27851

(15) 4.9.2012

(18) 7.5.2017

(21) 5015-2012

(22) 7.5.2012

(31) PVZ 2011-38883

(32) 13.12.2011

(33) CZ

(72) Kabaň Jozef, Mladá Boleslav, CZ;

(73) ŠKODA AUTO a. s., Mladá Boleslav, CZ;

(74) ROTT, RŮŽIČKA & GUTTMANN, Bratislava, SK;

(54) Svetelné vybavenie vozidla

Určenie výrobku:

Výrobky, v ktorých budú dizajny stelesnené, sú svetlomety a svetidlá vozidla.

(28) 4

(55)



1.1



1.2



1.3

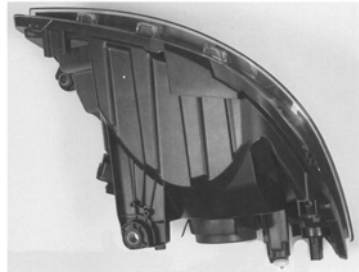

1.4

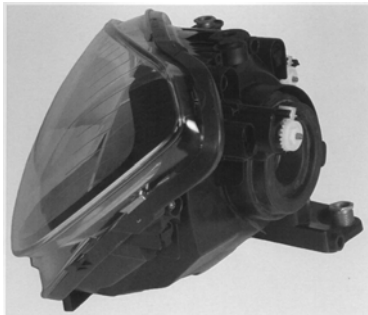

1.5

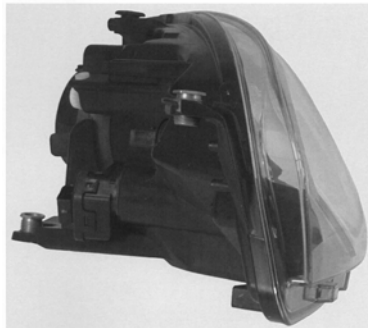

1.6



2.1



2.2

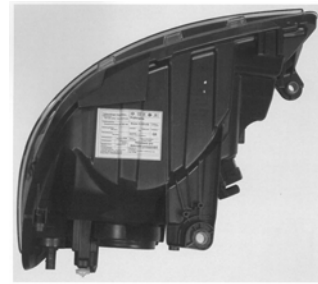

2.3

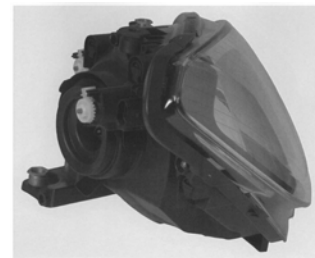

2.4



2.5



3.1



3.2



3.3



4.1

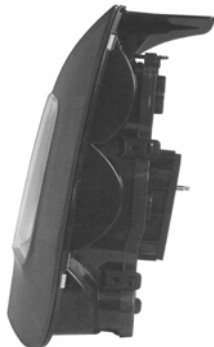

4.2



4.3

9 (51) 26/06.00

(11) 27848

(15) 4.9.2012

(18) 2.5.2017

(21) 5012-2012

(22) 2.5.2012

(73) DAF Trucks N.V., TW Eindhoven, NL;

(74) Fajnorová Mária, Ing., Bratislava, SK;

(54) Svetelné vybavenie vozidiel

Určenie výrobku:

Výrobky, ktorými sú tieto dizajny stelesnené, sú súčasťou automobilov a sú určené na zostavenie automobilov, pričom tvoria ich svetelné vybavenie.

(28) 6

(55)

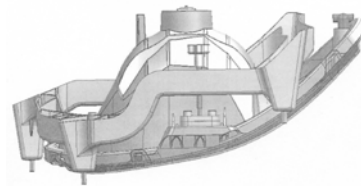

1.1

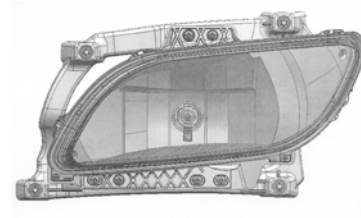

1.2

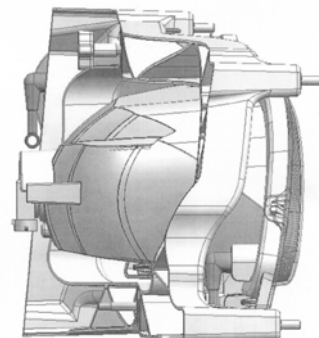

1.3

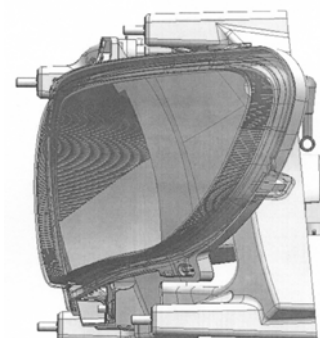

1.4

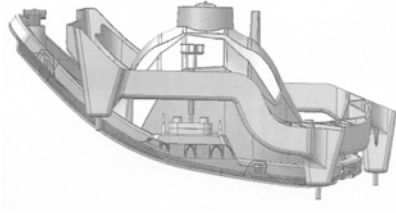

2.1

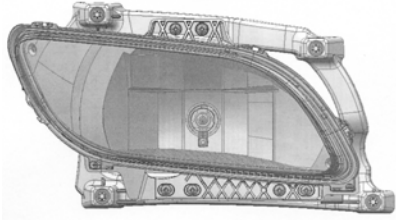

2.2

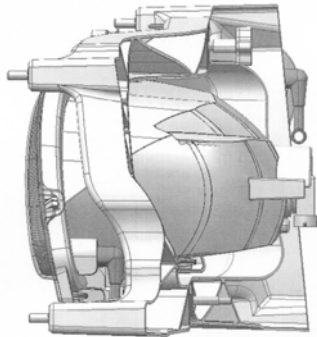

2.3

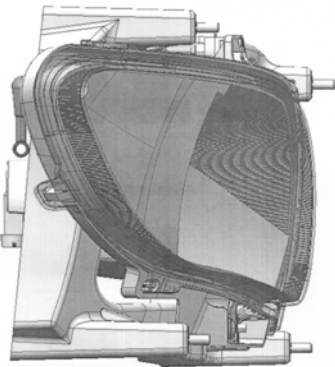

2.4

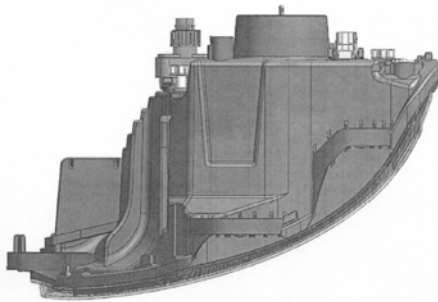

3.1

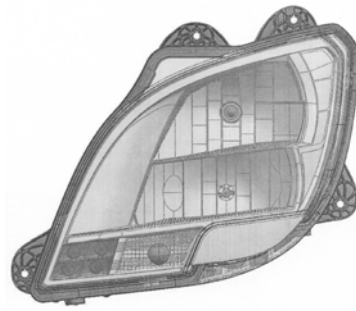

3.2

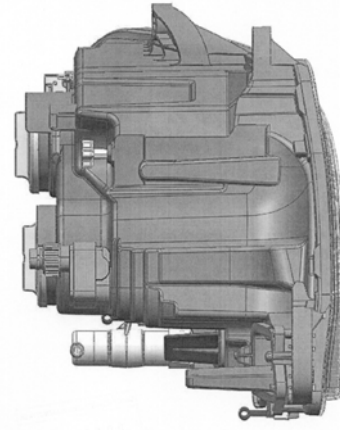

3.3

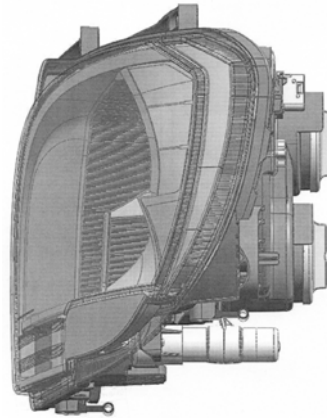

3.4

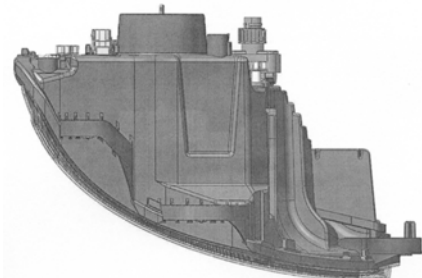

4.1

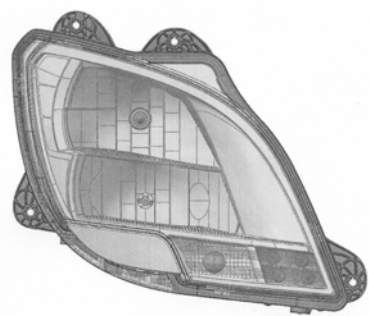

4.2

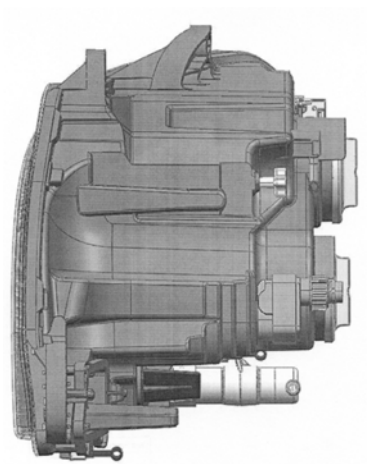

4.3

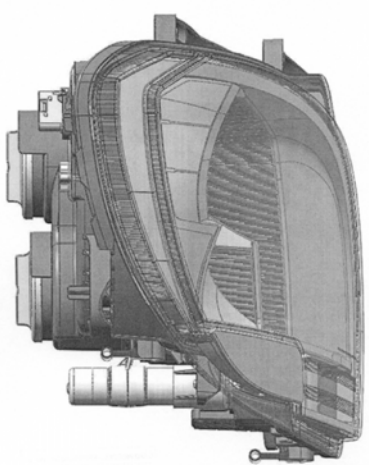

4.4

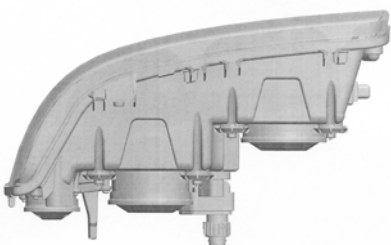

5.1

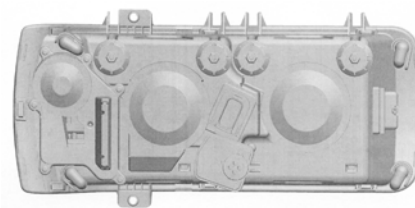

5.2

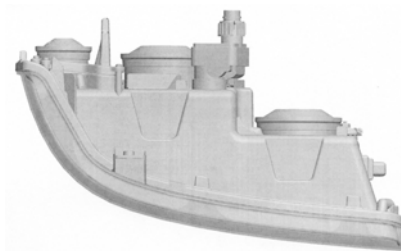

5.3

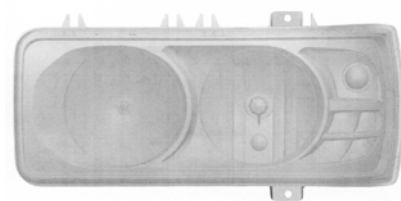

5.4

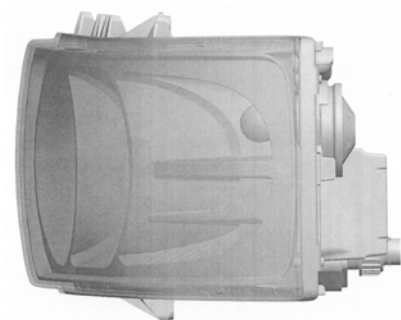

5.5

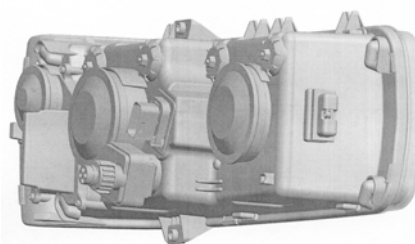

5.6

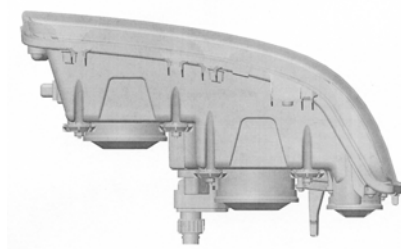

6.1

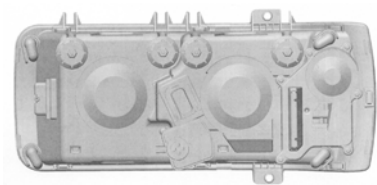

6.2

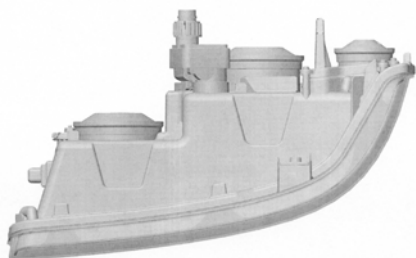

6.3

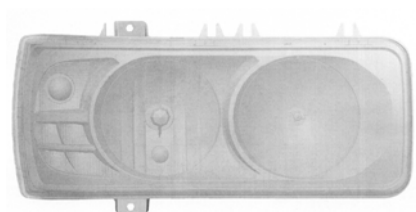

6.4

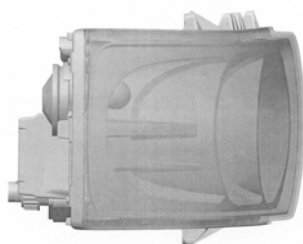

6.5

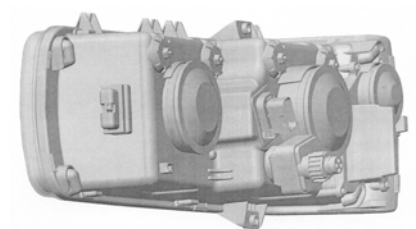

6.6

(51)	(11)	(51)	(11)	(51)	(11)	(51)	(11)
05/05.00	27859	08/06.00	27847	12/16.06	27850	25/03.01	27846
06/03.02	27856	11/99.00	27857	20/03.03	27853	26/06.00	27848
06/03.02	27858	12/08.04	27849	21/01.10	27854	26/06.00	27851
06/99.00	27855	12/16.06	27852				

FG4Q Zverejnené zapísané dizajny po uplynutí doby odkladu zverejnenia

(11) (51)
27657 19/01.00

9 (51) 19/01.00

(11) 27657

(21) 17-2010

(45) 7.9.2010

(73) IMAGE štúdio Slovensko, spol. s r.o., Michalovce, SK;

(54) Grafika maturitného oznámenia

Určenie výrobku:

Výrobok, v ktorom je dizajn stelesnený, predstavuje papiernický výrobok - maturitné oznámenie alebo iné oznámenie o spoločenskej udalosti, ktorý je podkladom pre následnú dotlač rôznych textov.

(28) 66

Oznámenie o zápise dizajnu do registra vo vestníku ÚPV SR č. 9/2010

(55)



1.1



2.1

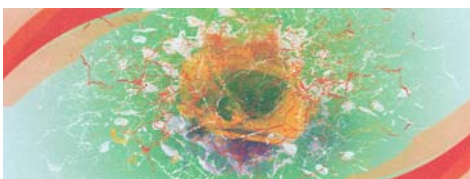

3.1



4.1



5.1



6.1



7.1



8.1



9.1



10.1



11.1



12.1



13.1

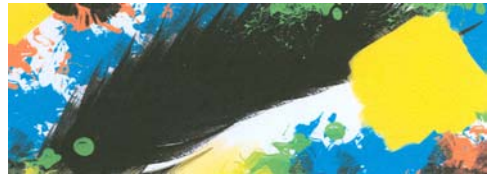

21.1



14.1



22.1



15.1

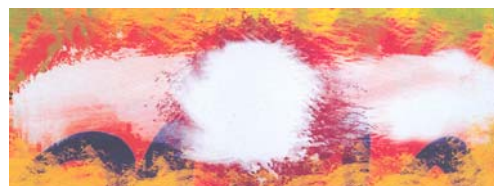

23.1



16.1



24.1

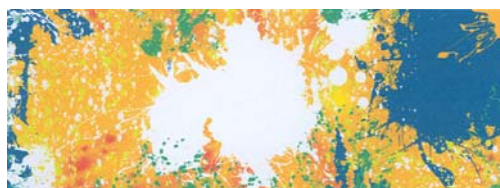

17.1



25.1



18.1



26.1



19.1



27.1



20.1



28.1



29.1



37.1



30.1



38.1



31.1



39.1



32.1



40.1



33.1



41.1

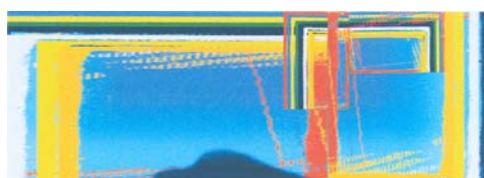

34.1



42.1



35.1



43.1



36.1



44.1



45.1



53.1

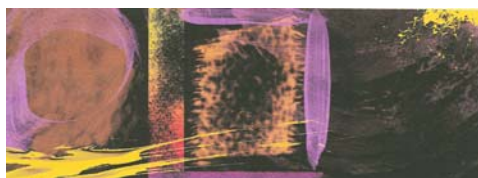

46.1



54.1



47.1



55.1



48.1



56.1



49.1



57.1



50.1



58.1



51.1



59.1



52.1



60.1



61.1



62.1



63.1



64.1



65.1



66.1

(51) (11)
19/01.00 27657

MK4Q Zaniknuté zapísané dizajny uplynutím doby platnosti

(11)	Dátum zániku	(11)	Dátum zániku	(11)	Dátum zániku	(11)	Dátum zániku
25501	10.09.2012	25515	11.09.2012	25518	11.09.2012	26571	21.02.2012
25504	17.09.2012	25516	11.09.2012	26518	01.02.2012	26625	01.02.2012
25505	24.09.2012	25517	11.09.2012	26532	05.02.2012	27361	22.02.2012

ND4Q Predĺženie platnosti zapísaných dizajnov

(11) (51)

26650 31/01.00
26712 11/03.00
26772 09/99.00
27477 12/99.00

7 (51) 09/99.00**(11) 26772**

(15) 20.11.2003

(18) 11.4.2018

(21) 61-2003

(22) 11.4.2003

(73) Inter IKEA Systems B. V., LN Delft, NL;

(54) Chránič hrán pre baliace účely

Určenie výrobku:

Výrobok, v ktorom je dizajn stelesnený, je chránič hrán slúžiaci na baliace účely.

7 (51) 11/03.00**(11) 26712**

(15) 26.8.2003

(18) 5.8.2017

(21) 158-2002

(22) 5.8.2002

(73) Akadémia vzdelávania, Bratislava, SK;

(54) Medaila

Určenie výrobku:

Výrobok, v ktorom je dizajn stelesnený alebo na ktorom bude aplikovaný, je určený ako medaila na vyznamenanie, odmenu, prípadne pamiatku.

8 (51) 12/99.00**(11) 27477**

(15) 26.8.2008

(18) 5.12.2017

(21) 61-2007

(22) 5.12.2007

(73) LANTIS, spol. s r.o., Trebišov, Trebišov, SK;

(54) Svetlo retroreflektívny štítok evidencie s trojdimenzionálnou úpravou a kompozitnými lenticulárnymi obrazmi ochranných prvkov

Určenie výrobku:

Výrobok, v ktorom je dizajn stelesnený alebo na ktorom je aplikovaný, je určený najmä na registračné a/alebo informatívne označenie materiálov, výrobkov, prostriedkov aj dopravných, objektov, osôb a zvierat.

7 (51) 31/01.00**(11) 26650**

(15) 15.5.2003

(18) 12.9.2017

(21) 195-2002

(22) 12.9.2002

(73) Plzeňský Prazdroj, a. s., Plzeň, CZ;

(54) Výchapná hlava II

Určenie výrobku:

Výrobok, v ktorom bude dizajn stelesnený alebo na ktorom bude aplikovaný, je výchapná hlava určená na vyčapovanie nápojov.

(51) (11)

09/99.00 26772
11/03.00 26712
12/99.00 27477
31/01.00 26650

PC4Q**Prevody a prechody práv**

(11) **27777**
(21) 37-2011
(78) dolphin, s.r.o., Žilina, SK;
Predchádzajúci majiteľ:
Valíček Štefan, Ing., Višňové, SK;
Dátum uzavretia zmluvy: 22.6.2012
(58) 20.9.2012

(11) **27806**
(21) 75-2011
(78) Mikula Andrej, Krompachy, SK;
Predchádzajúci majiteľ:
HASMA, s.r.o., Krompachy, SK;
Dátum uzavretia zmluvy: 2.8.2012
(58) 4.10.2012

TE4Q**Zmeny adries**

(11) **26461**
(21) 210-2001
(73) PEGASA, s. r. o., Bratislava, SK;
(58) 24.9.2012
