

ČASŤ

DIZAJNY

Číselné INID - kódy na označovanie bibliografických údajov (Štandard WIPO ST. 80)

(11)	Číslo zapísaného dizajnu	(51)	Medzinárodné triedenie dizajnov
(15)	Dátum zápisu/predĺženia platnosti	(54)	Názov dizajnu
(18)	Predpokladaný dátum uplynutia platnosti zápisu/predĺženia platnosti	(55)	Vyobrazenie dizajnu/vyobrazenie dizajnu po čiastočnom výmaze
(21)	Číslo prihlášky	(58)	Dátum záznamu v registri, napr. zmeny mena, zániku, výmazu a pod.
(22)	Dátum podania prihlášky	(62)	Číslo pôvodnej prihlášky v prípade vylúčenej prihlášky
(24)	Dátum nadobudnutia účinkov zapísaného dizajnu	(72)	Meno pôvodcu (-ov)
(28)	Počet dizajnov	(73)	Meno (názov) a adresa majiteľa (-ov)
(31)	Číslo prioritnej prihlášky	(74)	Meno (názov) a adresa zástupcu (-ov)
(32)	Dátum podania prioritnej prihlášky	(78)	Meno (názov) a adresa nového majiteľa (-ov) po prevode alebo prechode
(33)	Krajina alebo regionálna organizácia priority		
(45)	Dátum sprístupnenia zapísaného dizajnu		
(46)	Dátum uplynutia odkladu zverejnenia		

Poznámka:

Číslo uvádzané pred kódom (51) znamená verziu Medzinárodného triedenia dizajnov.

Kódy na označovanie záhlaví oznámení publikovaných vo Vestníku ÚPV SR (Štandard WIPO ST. 17)

FG4Q	Zapísané dizajny Zapísané dizajny s odloženým zverejnením Zverejnené zapísané dizajny po uplynutí doby odkladu zverejnenia
MA4Q	Zaniknuté zapísané dizajny vzdaním sa
MC4Q	Vymazané zapísané dizajny
MG4Q	Čiastočne vymazané zapísané dizajny
MK4Q	Zaniknuté zapísané dizajny uplynutím doby platnosti
ND4Q	Predĺženie platnosti zapísaných dizajnov
PC4Q	Prevody a prechody práv
PD4Q	Zmeny dispozičných práv na zapísané dizajny (zálohy)
PD4Q	Zmeny dispozičných práv na zapísané dizajny (ukončenie zálohov)
QB4Q	Licenčné zmluvy registrované
QC4Q	Ukončenie platnosti licenčných zmlúv
TA4Q	Doplnenie pôvodcu (-ov)
TB4Q	Opravy mien
TC4Q	Zmeny mien
TD4Q	Opravy adries
TE4Q	Zmeny adries
TF4Q	Opravy dátumov
TG4Q	Opravy zatriedenia podľa Medzinárodného triedenia dizajnov
TH4Q	Opravy chýb alebo zmeny všeobecne
TK4Q	Opravy tlačových chýb vo Vestníku ÚPV SR

FG4Q

Zapísané dizajny

(11) (51)

27749 09/01.01
 27750 12/16.13
 27751 12/16.13
 27752 12/16.06

9 (51) 09/01.01

(11) 27749

(15) 6.10.2011

(18) 1.4.2016

(21) 20-2011

(22) 1.4.2011

(24) 6.10.2011

(72) Miklušica Pavol, Bratislava, SK;

(73) IMPERATOR, s.r.o., Drietoma, SK;

(74) Kubínyi Peter, Bc., Trenčín, SK;

(54) Fľaša a etiketa fľaše

Určenie výrobku:

Výrobok, v ktorom je dizajn stelesnený a na ktorom je použitý, je fľaša a etiketa fľaše.

(28) 2

(55)



1.4



1.1



1.5



1.2



1.6



1.3



2.1



2.2



2.3



2.4



2.5



2.6

9 (51) 12/16.06, 12/16.11

(11) 27752

(15) 6.10.2011

(18) 13.5.2016

(21) 28-2011

(22) 13.5.2011

(24) 6.10.2011

(31) SE 2010/0521, SE 2010/0522, SE 2010/0520, SE 2010/0519, SE 2010/0518, SE 2010/0517

(32) 15.11.2010, 15.11.2010, 15.11.2010, 15.11.2010, 15.11.2010, 15.11.2010

(33) SE, SE, SE, SE, SE, SE

(72) Söderberg Pehr, Södertälje, SE; Hansén Kristofer, Stockholm, SE; Henriksen Christian, Hässelby, SE; Carreras-Castro Xavier, Lidingö, SE;

(73) SCANIA CV AB, Södertälje, SE;

(74) Bačík Kvetoslav, Ing., Nová Dubnica, SK;

(54) Diely karosérie vozidla

Určenie výrobku:

Výrobky, v ktorých sú dizajny hromadnej prihlášky stelesnené, sú dielmi karosérie vozidla:

1. Predné stúpadlo
2. Nárazník
3. Kryt stúpadla
4. Kryt stúpadla
5. Šachta
6. Čelný poklop
7. Zadná ochranná platňa
8. Stredná ochranná platňa
9. Rohový kryt
10. Rohový kryt

(28) 10

(55)

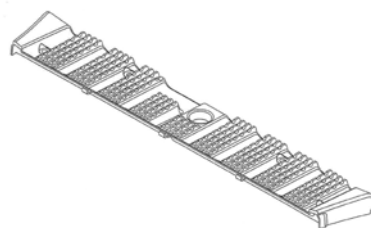

1.1

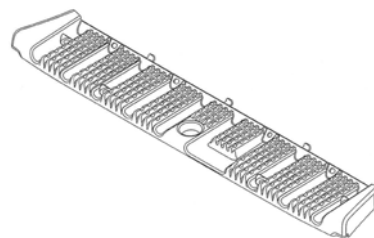

1.2



1.3



1.4

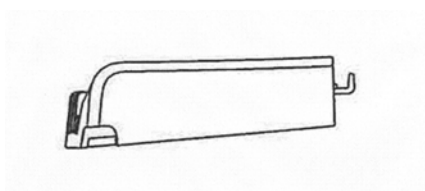

1.5

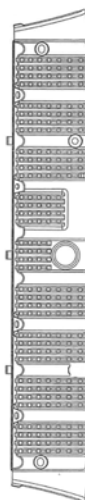

1.6

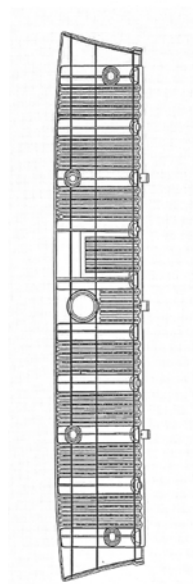

1.7

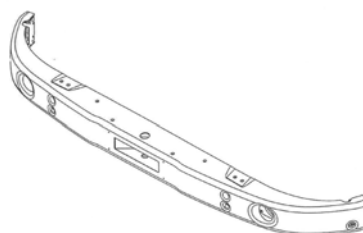

2.1

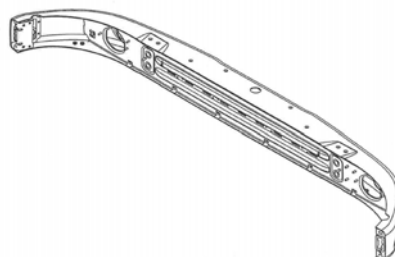

2.2



2.3



2.4

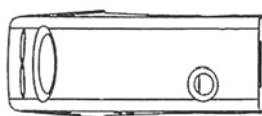

2.5

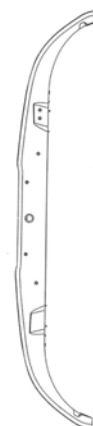

2.6



2.7

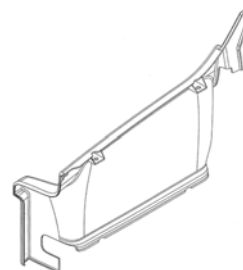

3.1

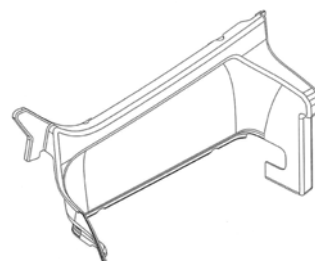

3.2

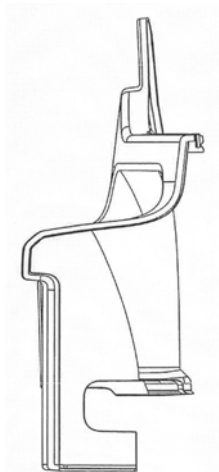

3.3

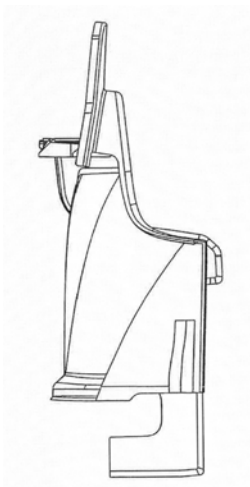

3.4

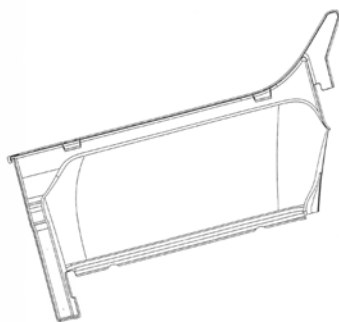

3.5

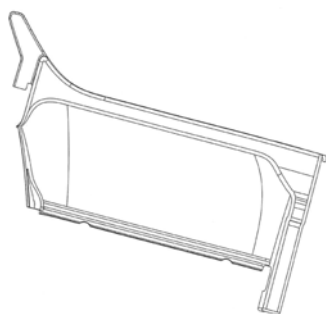

3.6

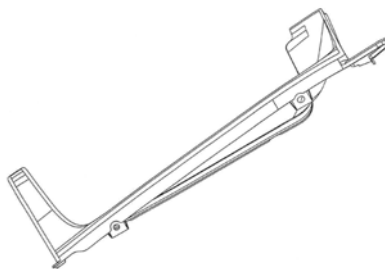

3.7

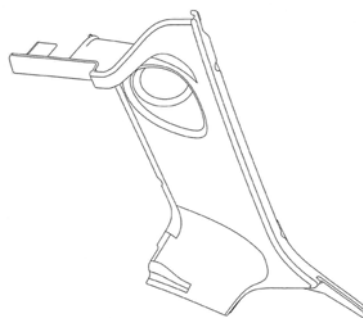

4.1

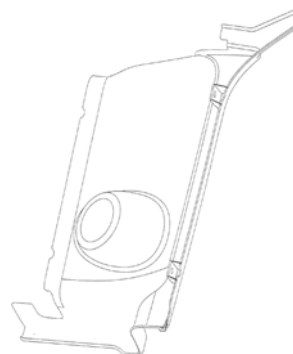

4.2



4.3

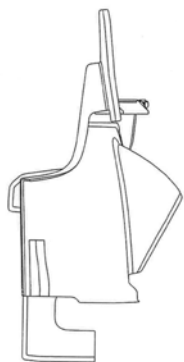

4.4

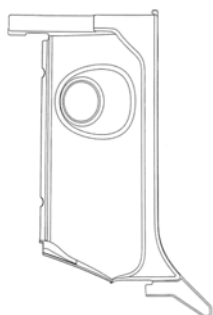

4.5

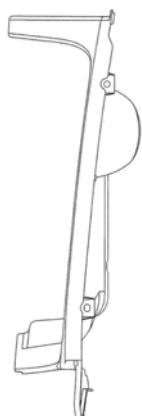

4.6



4.7

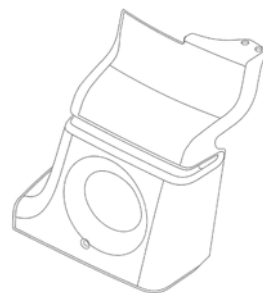

5.1

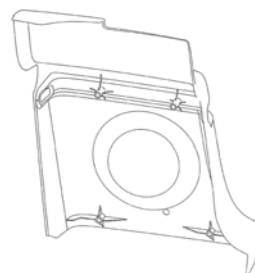

5.2



5.3

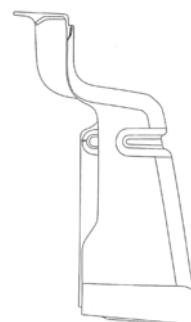

5.4



5.5



5.6

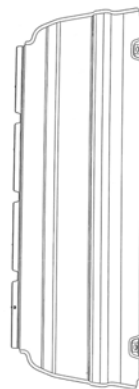

6.3

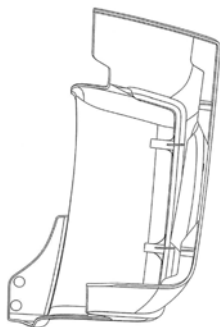

5.7



6.4

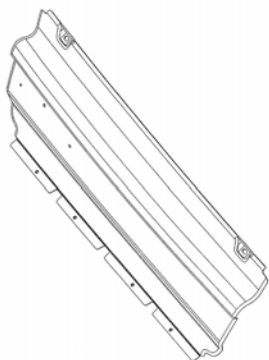

6.1



6.5

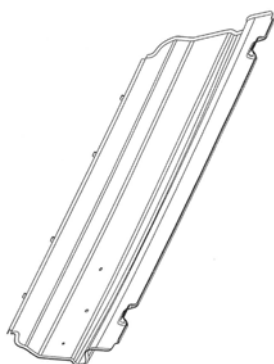

6.2



6.6



6.7

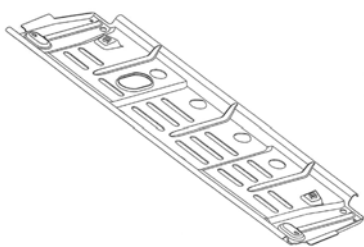

7.1

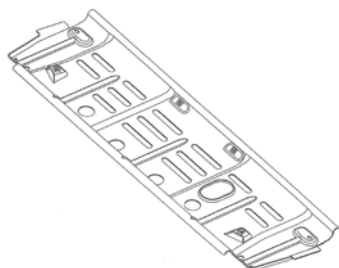

7.2



7.3



7.4



7.5

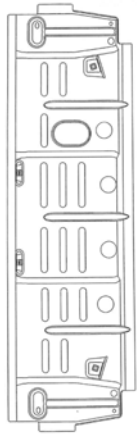

7.6



8.3

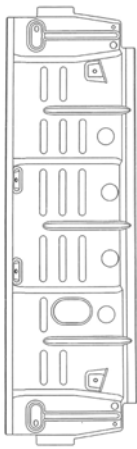

7.7



8.4

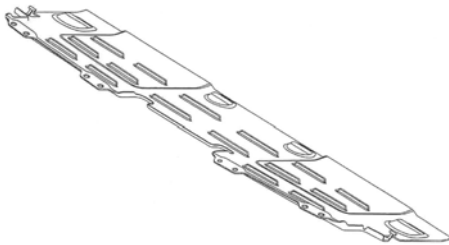

8.1

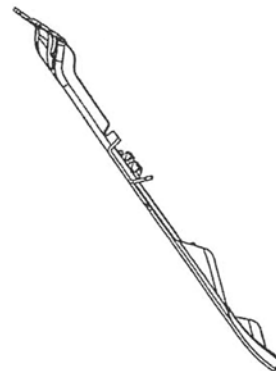

8.5

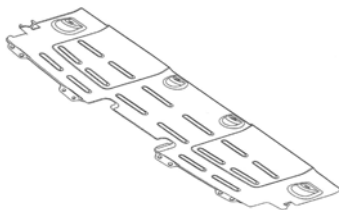

8.2

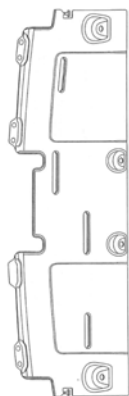

8.6

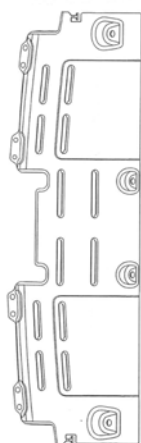

8.7



9.1

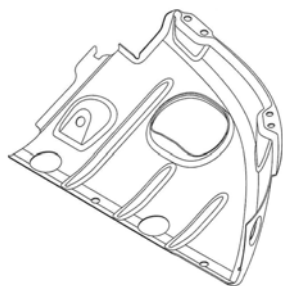

9.2



9.3

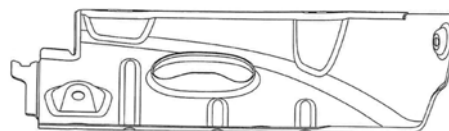

9.4

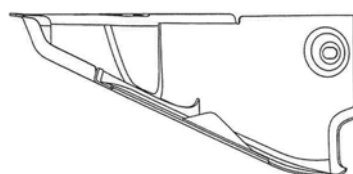

9.5

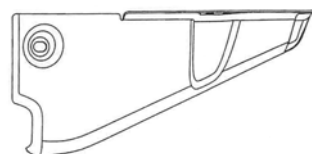

9.6



9.7

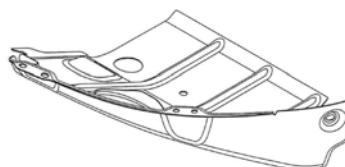

10.1

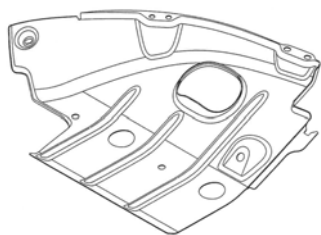

10.2

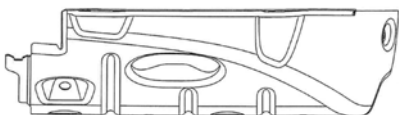

10.3

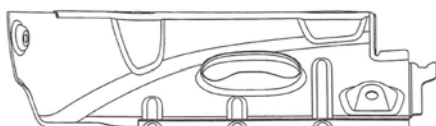

10.4

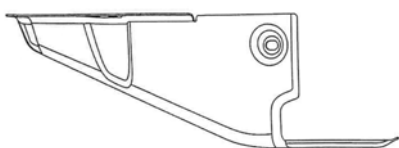

10.5

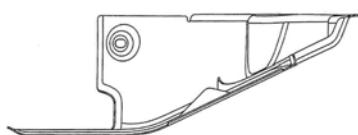

10.6

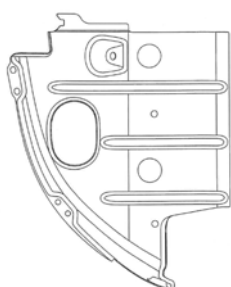

10.7

9 (51) 12/16.13

(11) 27751

(15) 6.10.2011

(18) 28.4.2016

(21) 24-2011

(22) 28.4.2011

(24) 6.10.2011

(31) 2010/0495

(32) 2.11.2010

(33) SE

(72) Fagerström Kjell, Järna, SE; Carreras-Castro Xavier, Lidingö, SE; Hansén Kristofer, Stockholm, SE; Larsson Mikael, Arsta, SE; Schmidt Klaus, Tullinge, SE;

(73) SCANIA CV AB, Södertälje, SE;

(74) Bačfk Kvetoslav, Ing., Nová Dubnica, SK;

(54) Krycí panel vozidiel

Určenie výrobku:

Výrobok, v ktorom je dizajn stelesnený, je určený ako krycí panel motorových vozidiel.

(28) 1

(55)



1.1



1.2



1.3



1.4



1.5



1.6



1.7

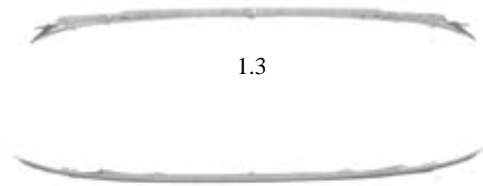

1.3

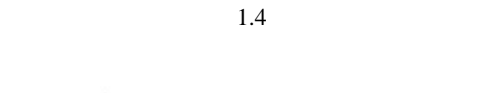

1.4



1.5



1.6



1.7

9 (51) 12/16.13

(11) **27750**

(15) 6.10.2011

(18) 28.4.2016

(21) 23-2011

(22) 28.4.2011

(24) 6.10.2011

(31) 2010/0496

(32) 2.11.2010

(33) SE

(72) Fagerström Kjell, Järna, SE; Carreras-Castro Xavier, Lidingö, SE; Hansén Kristofer, Stockholm, SE; Larsson Mikael, Arsta, SE; Schmidt Klaus, Tullinge, SE;

(73) SCANIA CV AB, Södertälje, SE;

(74) Bačík Kvetoslav, Ing., Nová Dubnica, SK;

(54) Čelný mriežkový panel vozidiel

Určenie výrobku:

Výrobok, v ktorom je dizajn stelesnený, je určený ako čelný mriežkový panel motorových vozidiel.

(28) 1

(55)

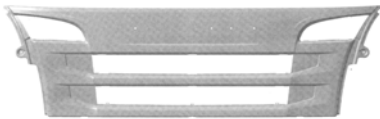

1.1

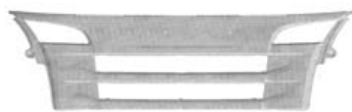

1.2

(51) (11)

09/01.01 27749

12/16.06 27752

12/16.13 27751

12/16.13 27750

MC4Q**Vymazané zapísané dizajny**

- (11) **26265**
 (21) 154-2000
 (22) 24.7.2000
 (54) **Súbor poštových schránok**
 (58) 10.8.2011
-

MK4Q**Zaniknuté zapísané dizajny uplynutím doby platnosti**

(11)	Dátum zániku	(11)	Dátum zániku	(11)	Dátum zániku	(11)	Dátum zániku
25074	10.09.2011	25233	18.09.2011	26328	09.02.2011	27261	09.02.2011
25187	23.09.2011	25234	18.09.2011	26340	16.02.2011	27284	20.02.2011
25204	25.09.2011	26318	21.02.2011	26381	28.02.2011	27285	21.02.2011
25231	18.09.2011	26327	09.02.2011	27260	09.02.2011	27297	21.02.2011

ND4Q**Predĺženie platnosti zapísaných dizajnov**

(11)	(51)	(11)	(51)	(11)	(51)	(11)	(51)
26422	19/07.02	26450	19/06.08	26454	09/01.03	27302	19/01.00
26449	19/06.08	26453	11/02.04	26458	09/01.01		

- 7 (51) 09/01.01**
 (11) **26458**
 (15) 26.3.2002
 (18) 14.9.2016
 (21) 187-2001
 (22) 14.9.2001
 (73) Reckitt Benckiser N. V., Hoofddorp, NL;
 (54) **Plastová fľaša II**
-

- 7 (51) 09/01.03**
 (11) **26454**
 (15) 26.3.2002
 (18) 3.9.2016
 (21) 181-2001
 (22) 3.9.2001
 (73) Liptovská mliekareň, a. s., Liptovský Mikuláš, SK;
 (54) **Téglik s uzatvárateľným vekom**
-

- 7 (51) 11/02.04**
 (11) **26453**
 (15) 26.3.2002
 (18) 3.9.2016
 (21) 180-2001
 (22) 3.9.2001
 (73) Liptovská mliekareň, a. s., Liptovský Mikuláš, SK;
 (54) **Keramická nádoba s téglíkmi**
-

- 8 (51) 19/01.00**
 (11) **27302**
 (15) 30.11.2006
 (18) 20.9.2016
 (21) 43-2006
 (22) 20.9.2006
 (73) SLOVENSKÁ POŠTA, a.s., Banská Bystrica, SK;
 (54) **Doručenková obálka**
 Určenie výrobku:
 Výrobok, v ktorom je dizajn stelesnený alebo na ktorom je použitý, je určený na použitie ako doručenková obálka.
-

- 7 (51) 19/06.08**
 (11) **26450**
 (15) 18.3.2002
 (18) 16.10.2016
 (21) 205-2001
 (22) 16.10.2001
 (73) Henkel Kommanditgesellschaft auf Aktien, Düsseldorf, DE;
 (54) **Korektor**
-

7 (51) 19/06.08
 (11) 26449
 (15) 18.3.2002
 (18) 16.10.2016
 (21) 204-2001
 (22) 16.10.2001
 (73) Henkel Kommanditgesellschaft auf Aktien, Düsseldorf, DE;
 (54) **Korektor**

7 (51) 19/07.02
 (11) 26422
 (15) 16.1.2002
 (18) 31.7.2016
 (21) 163-2001
 (22) 31.7.2001
 (73) Zachar Roman, Ing., Brezno, SK;
 (54) **Drevené puzzle - mapy**

(51)	(11)	(51)	(11)	(51)	(11)	(51)	(11)
09/01.01	26458	11/02.04	26453	19/06.08	26449	19/07.02	26422
09/01.03	26454	19/01.00	27302	19/06.08	26450		

PC4Q

Prevody a prechody práv

(11) 26935
 (21) 10-2004
 (78) S. C. Johnson & Son, Inc., a Wisconsin corporation, Racine, Wisconsin, US;
 Predchádzajúci majiteľ:
 Kiwi European Holdings B. V., Utrecht, NL;
 (58) 7.9.2011
