

**ČAŠŤ**

**DIZAJNY**

### Číselné INID - kódy na označovanie bibliografických údajov (Štandard WIPO ST. 80)

(11)	Číslo zapísaného dizajnu	(51)	Medzinárodné triedenie dizajnov
(15)	Dátum zápisu/predĺženia platnosti	(54)	Názov dizajnu
(18)	Predpokladaný dátum uplynutia platnosti zápisu/predĺženia platnosti	(55)	Vyobrazenie dizajnu/vyobrazenie dizajnu po čiastočnom výmaze
(21)	Číslo prihlášky	(58)	Dátum záznamu v registri, napr. zmeny mena, zániku, výmazu a pod.
(22)	Dátum podania prihlášky	(62)	Číslo pôvodnej prihlášky v prípade vylúčenej prihlášky
(24)	Dátum nadobudnutia účinkov zapísaného dizajnu	(72)	Meno pôvodcu (-ov)
(28)	Počet dizajnov	(73)	Meno (názov) a adresa majiteľa (-ov)
(31)	Číslo prioritnej prihlášky	(74)	Meno (názov) a adresa zástupcu (-ov)
(32)	Dátum podania prioritnej prihlášky	(78)	Meno (názov) a adresa nového majiteľa (-ov) po prevode alebo prechode
(33)	Krajina alebo regionálna organizácia priority		
(45)	Dátum sprístupnenia zapísaného dizajnu		
(46)	Dátum uplynutia odkladu zverejnenia		

Poznámka:

Číslo uvádzané pred kódom (51) znamená verziu Medzinárodného triedenia dizajnov.

### Kódy na označovanie záhlaví oznámení publikovaných vo Vestníku ÚPV SR (Štandard WIPO ST. 17)

<b>FG4Q</b>	Zapísané dizajny Zapísané dizajny s odloženým zverejnením Zverejnené zapísané dizajny po uplynutí doby odkladu zverejnenia
<b>MA4Q</b>	Zaniknuté zapísané dizajny vzdáním sa
<b>MC4Q</b>	Vymazané zapísané dizajny
<b>MG4Q</b>	Čiastočne vymazané zapísané dizajny
<b>MK4Q</b>	Zaniknuté zapísané dizajny uplynutím doby platnosti
<b>ND4Q</b>	Predĺženie platnosti zapísaných dizajnov
<b>PC4Q</b>	Prevody a prechody práv
<b>PD4Q</b>	Zmeny dispozičných práv na zapísané dizajny (zálohy)
<b>PD4Q</b>	Zmeny dispozičných práv na zapísané dizajny (ukončenie zálohov)
<b>QB4Q</b>	Licenčné zmluvy registrované
<b>QC4Q</b>	Ukončenie platnosti licenčných zmlúv
<b>TA4Q</b>	Doplnenie pôvodcu (-ov)
<b>TB4Q</b>	Opravy mien
<b>TC4Q</b>	Zmeny mien
<b>TD4Q</b>	Opravy adries
<b>TE4Q</b>	Zmeny adries
<b>TF4Q</b>	Opravy dátumov
<b>TG4Q</b>	Opravy zatriedenia podľa Medzinárodného triedenia dizajnov
<b>TH4Q</b>	Opravy chýb alebo zmeny všeobecne
<b>TK4Q</b>	Opravy tlačových chýb vo Vestníku ÚPV SR

## FG4Q

## Zapísané dizajny

(11)	(51)	(11)	(51)	(11)	(51)	(11)	(51)
27735	25/03.01	27738	02/03.00	27741	22/99.00	27744	06/01.11
27736	12/03.02	27739	24/01.02	27742	20/02.02	27745	26/06.00
27737	30/06.00	27740	09/01.01	27743	20/02.02		

**9 (51) 02/03.00****(11) 27738**

(15) 27.7.2011

(18) 10.3.2016

(21) 11-2011

(22) 10.3.2011

(24) 27.7.2011

(72) Lepótová Lívia, Ing., Liptovský Mikuláš, SK;

(73) Lepótová Lívia, Ing., Liptovský Mikuláš, SK;

**(54) Klobúk do dažďa**

Určenie výrobku:

Výrobok, v ktorom je stelesnený dizajn, je určený ako pokrývka hlavy.

(28) 1

(55)



1.1

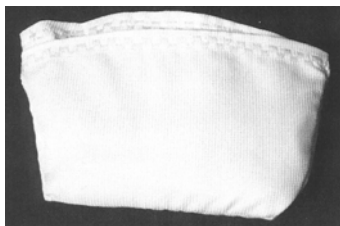

1.2



1.3

**9 (51) 06/01.11****(11) 27744**

(15) 27.7.2011

(18) 23.3.2016

(21) 5002-2011

(22) 23.3.2011

(24) 27.7.2011

(72) Paldan František, Ing., Bratislava, SK;

(73) Paldan František, Ing., Bratislava, SK;

**(54) Rám lavičky**

Určenie výrobku:

Výrobok, v ktorom je dizajn stelesnený, je určený ako rám lavičky.

(28) 1

(55)

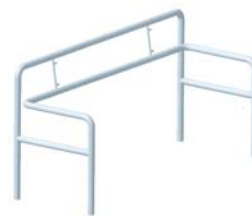

1.1



1.2



1.3



1.4

9 (51) 09/01.01

(11) 27740

(15) 27.7.2011

(18) 23.3.2016

(21) 14-2011

(22) 23.3.2011

(24) 27.7.2011

(72) Rojko Juraj, Ing., Nitra, SK;

(73) Pálenica Jelšovce s.r.o., Jelšovce, SK;

(54) Sklenená fľaša 0,35 l

Určenie výrobku:

Výrobok, v ktorom je dizajn stelesnený, je určený ako fľaša na nápoje.

(28) 1

(55)



1.1



1.2

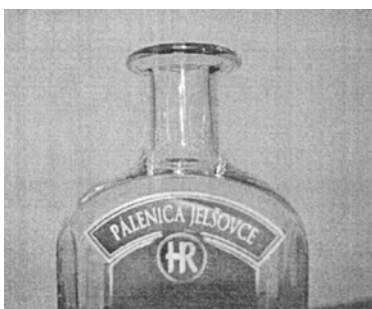

1.3

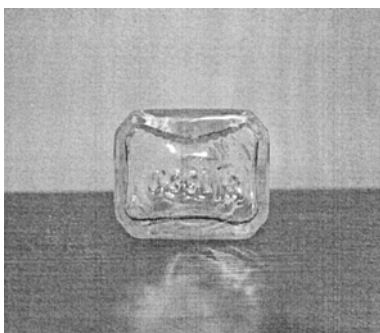

1.4

9 (51) 12/03.02

(11) 27736

(15) 27.7.2011

(18) 3.12.2015

(21) 5020-2010

(22) 3.12.2010

(24) 27.7.2011

(31) PVZ 2010-38276

(32) 13.6.2010

(33) CZ

(72) Kadlec Milan, Havlíčkův Brod, CZ;

(73) CZ LOKO, a.s., Česká Třebová, CZ;

(74) MAJLINGOVÁ & PARTNERS, s.r.o., Bratislava, SK;

(54) Kabína lokomotívy

Určenie výrobku:

Výrobok, v ktorom sú dizajny stelesnené, predstavuje kabínu strojvedúceho dieselelektrickej lokomotívy - kabína lokomotívy, interiér a dvojpedálový stupienok.

(28) 3

(55)

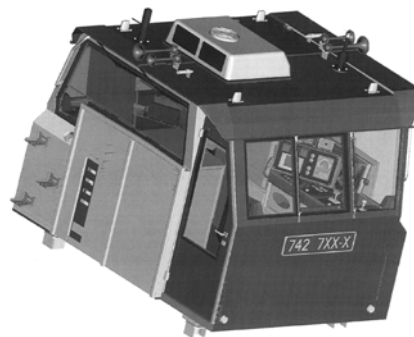

1.1

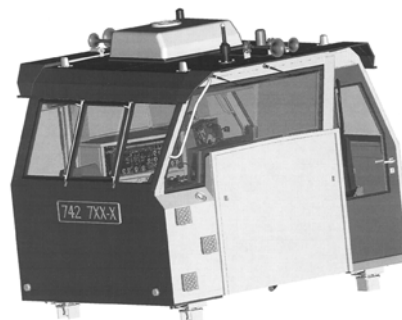

1.2

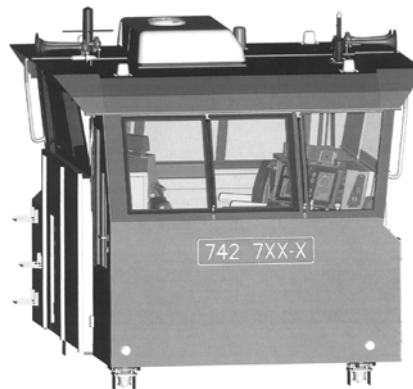

1.3

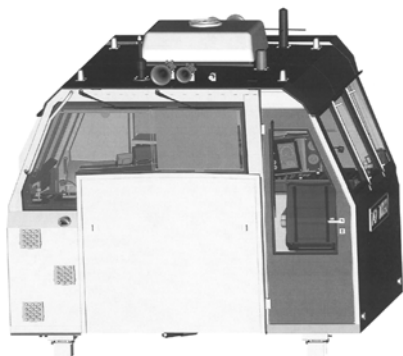

1.4

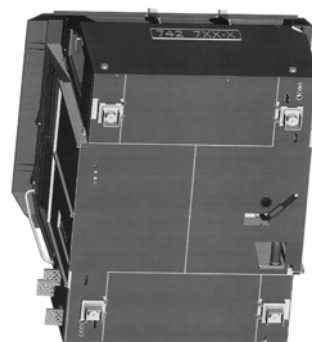

1.8



1.5

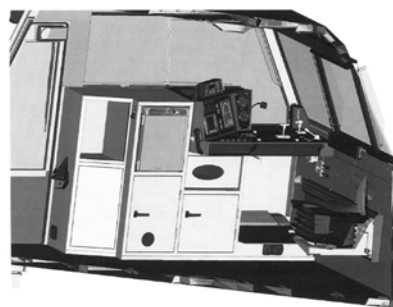

2.1

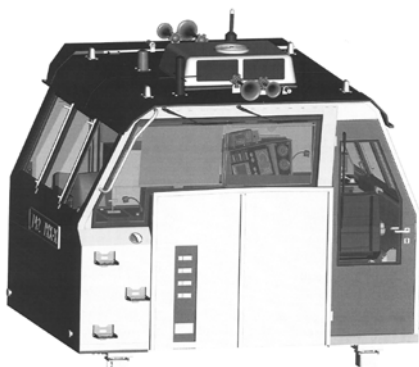

1.6



2.2

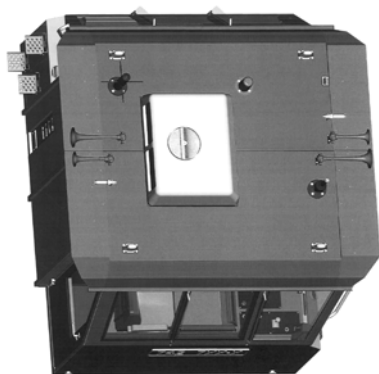

1.7

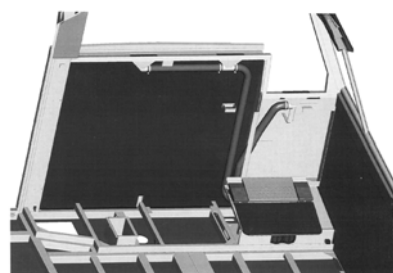

2.3



2.4

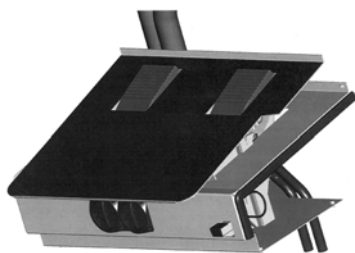

3.1

9 (51) 20/02.02

(11) 27742

(15) 27.7.2011

(18) 29.3.2016

(21) 17-2011

(22) 29.3.2011

(24) 27.7.2011

(72) Sklenár Pavel, Ing., Martin, SK;

(73) Triumf professional tools s.r.o., Martin, SK;

(74) Brichtová Tatiana, JUDr., Bratislava, SK;

(54) **Stojan na vystavovanie a prezentáciu tovaru**

Určenie výrobku:

Výrobok podľa dizajnu, v ktorom je stelesnené vonkajšie tvarové riešenie stojana pripomínajúceho nákupný vozík, je určený na zariadenie interiérových priestorov výstavných a predajných miest tovarov.

(28) 1

(55)



1.1



1.2



1.3



1.4

9 (51) 20/02.02

(11) 27743

(15) 27.7.2011

(18) 29.3.2016

(21) 18-2011

(22) 29.3.2011

(24) 27.7.2011

(72) Sklenár Pavel, Ing., Martin, SK;

(73) Triumf professional tools s.r.o., Martin, SK;

(74) Brichtová Tatiana, JUDr., Bratislava, SK;

(54) **Stojan na vystavovanie a/alebo prezentáciu tovaru**

Určenie výrobku:

Výrobok podľa dizajnu, v ktorom je stelesnené vonkajšie tvarové riešenie stojana pripomínajúceho nákupný vozík, je určený na zariadenie interiérových priestorov výstavných a predajných miest tovarov.

(28) 1

(55)



1.1



1.2



1.3



1.4



1.5

9 (51) 22/99.00

(11) 27741

(15) 27.7.2011

(18) 25.3.2016

(21) 15-2011

(22) 25.3.2011

(24) 27.7.2011

(72) Kollár Svetoslav, Ing., Trenčín, SK;

(73) KONŠTRUKTA-DEFENCE, a. s., Trenčín, SK;

(54) Úst'ová brzda

Určenie výrobku:

Výrobok, v ktorom je dizajn stelesnený, je úst'ová brzda, ktorá je určená na montáž na ústie hlavne strelnej zbrane.

(28) 1

(55)

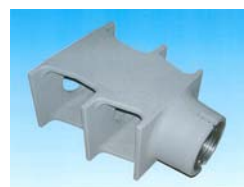

1.1

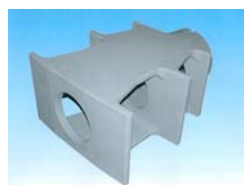

1.2

9 (51) 24/01.02

(11) 27739

(15) 27.7.2011

(18) 11.3.2016

(21) 12-2011

(22) 11.3.2011

(24) 27.7.2011

(72) Tomaščík Jaroslav, Mgr., Liptovský Mikuláš, SK;

Kobelár Roman, Ing., Piešťany, SK; Kment Jaroslav, Ing., Piešťany, SK;

(73) Chirana - Dental, s.r.o., Piešťany, SK;

(54) Stomatologická súprava DIPLOMAT ADEPT DA 370

Určenie výrobku:

Výrobok, v ktorom je dizajn stelesnený, je stomatologická súprava určená pre stomatológov s možnosťou vykonávania všetkých druhov prác v stomatologickej praxi.

(28) 1

(55)



1.1



1.2



1.3



1.4



1.5

9 (51) 25/03.01

(11) 27735

(15) 27.7.2011

(18) 17.12.2015

(21) 76-2010

(22) 17.12.2010

(24) 27.7.2011

(72) Majko Miloš, Sereď, SK;

(73) STAVTECH TEAM, s.r.o., Sereď, SK;

(74) Beleščák Ladislav, Ing., Piešťany, SK;

(54) **Obytný dom**

Určenie výrobku:

Výrobok, na ktorom je dizajn stelesnený alebo na ktorom je použitý, je dom, ktorý je určený najmä na bývanie osôb.

(28) 3

(55)

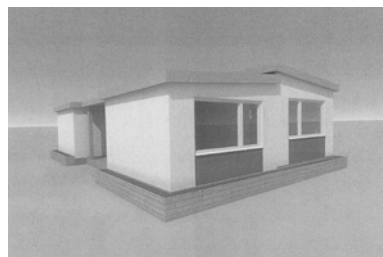

1.1

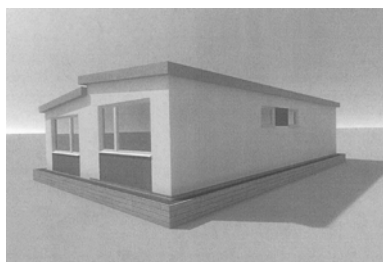

1.2

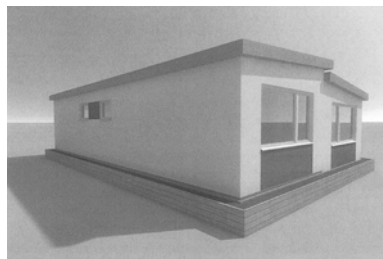

1.3

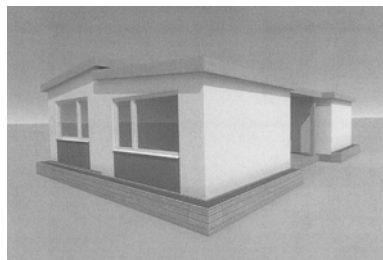

1.4



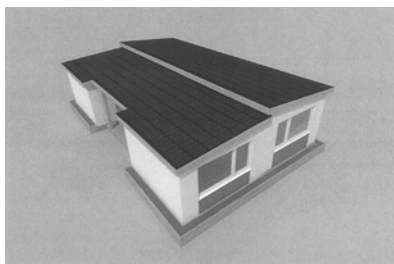

1.5

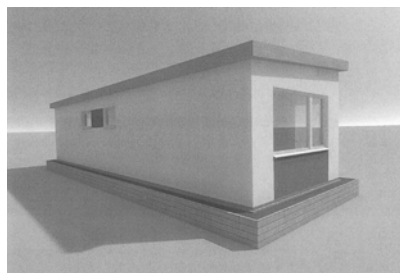

2.3

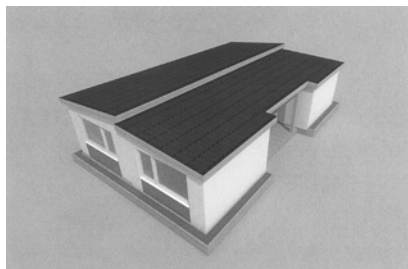

1.6

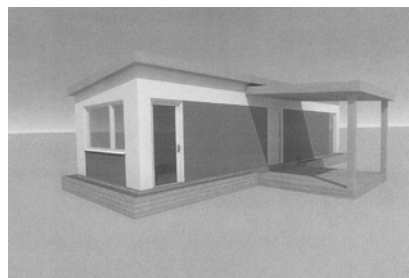

2.4

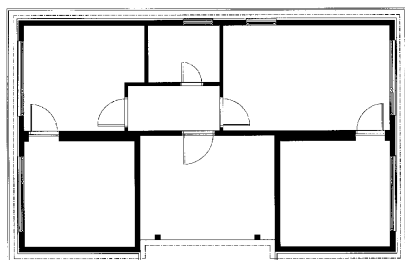

1.7

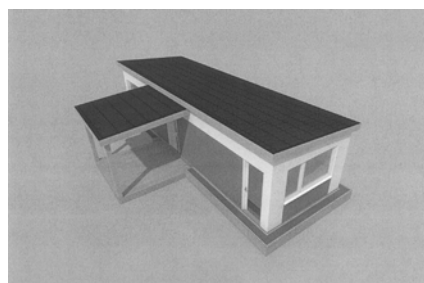

2.5

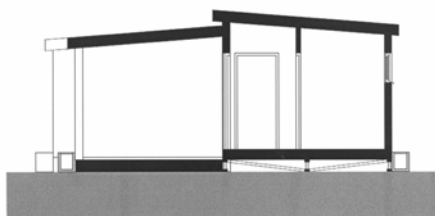

1.8

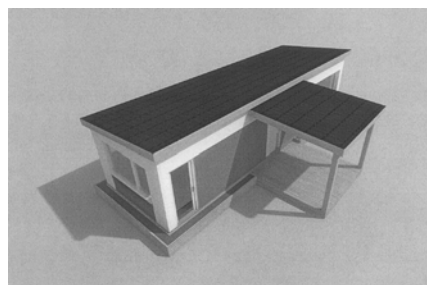

2.6

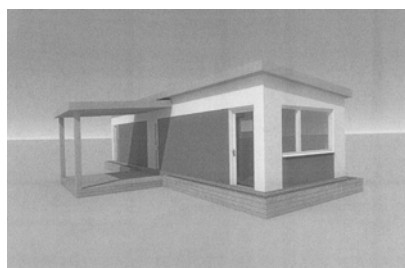

2.1

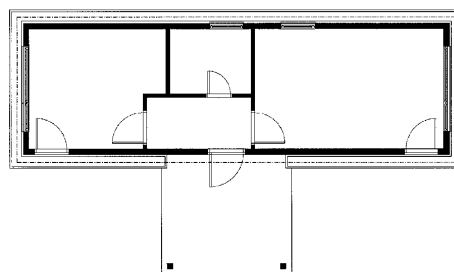

2.7

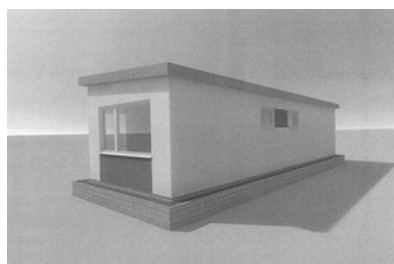

2.2

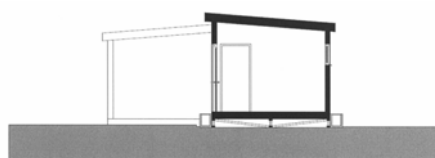

2.8

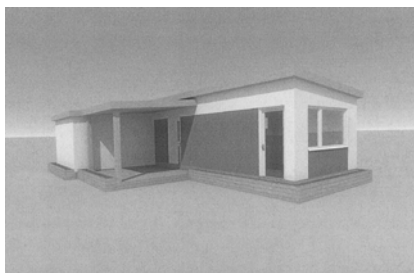

3.1

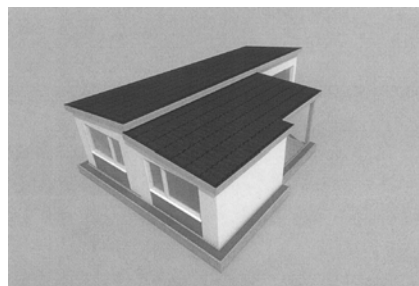

3.6

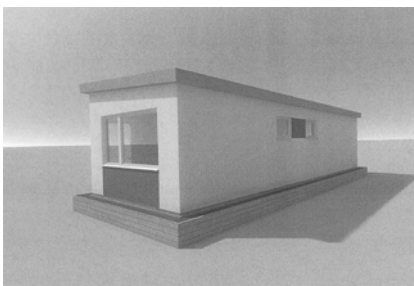

3.2

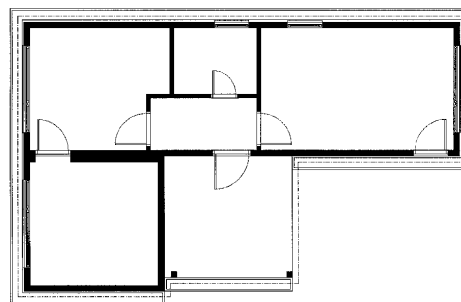

3.7

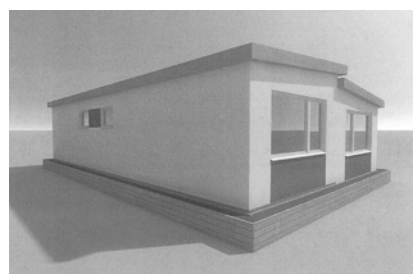

3.3

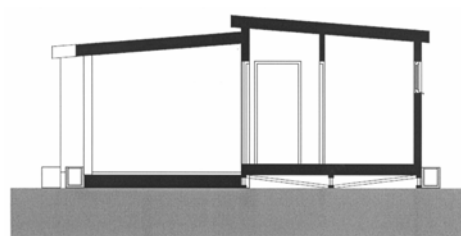

3.8

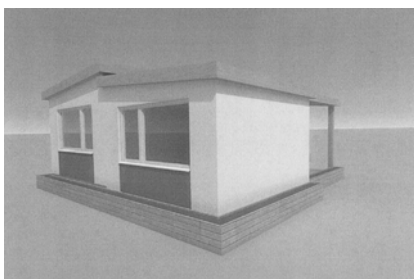

3.4

9 (51) 26/06.00

(11) 27745

(15) 29.7.2011

(18) 16.3.2016

(21) 13-2011

(22) 16.3.2011

(24) 29.7.2011

(72) Valíček Štefan, Ing., Višňové, SK; Marjak Ľubomír, Mgr., Skalité, SK;

(73) Valíček Štefan, Ing., Višňové, SK;

(74) Labudík Miroslav, Ing., Kysucké Nové Mesto, SK;

(54) **Predné brzdomé svetlo motorového vozidla**

Určenie výrobku:

Predné brzdomé svetlo motorového vozidla je určené na prednú a prípadne i bočnú svetelnú signalizáciu brzdzenia motorového vozidla účastníkom cestnej prevádzky.

(28) 40

(55)

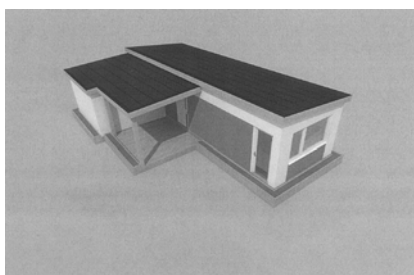

3.5



1.1



2.1



8.1



3.1



9.1



4.1



10.1



5.1

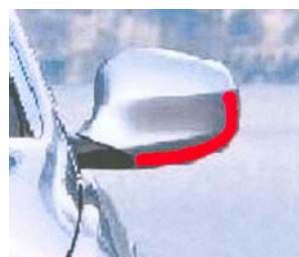

11.1



6.1



12.1



7.1



13.1



14.1



20.1

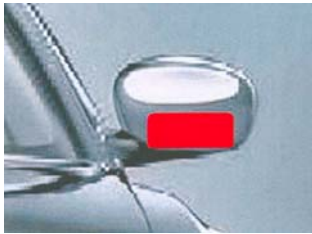

15.1



21.1



16.1



22.1



17.1



23.1



18.1



24.1



19.1



25.1



26.1



27.1



34.1



28.1



35.1



29.1



36.1



30.1



37.1



31.1



38.1



32.1



39.1



33.1



40.1

9 (51) 30/06.00

(11) 27737

(15) 27.7.2011

(18) 10.3.2016

(21) 10-2011

(22) 10.3.2011

(24) 27.7.2011

(72) Nuchalik Martin, Ing., Šaľa, SK;

(73) Nuchalik Martin, Ing., Šaľa, SK;

(54) **Posteľ pre psov z masívneho dreva**

Určenie výrobku:

Výrobok, v ktorom je dizajn stelesnený, je posteľ určená na oddych a spánok psov.

(28) 1

(55)



1.1



1.2



1.3



1.4

---

(51)	(11)	(51)	(11)	(51)	(11)	(51)	(11)
02/03.00	27738	12/03.02	27736	22/99.00	27741	26/06.00	27745
06/01.11	27744	20/02.02	27743	24/01.02	27739	30/06.00	27737
09/01.01	27740	20/02.02	27742	25/03.01	27735		

**MK4Q Zaniknuté zapísané dizajny uplynutím doby platnosti**

(11)	Dátum zániku	(11)	Dátum zániku	(11)	Dátum zániku	(11)	Dátum zániku
25193	25.07.2011	26331	08.12.2010	27244	08.12.2010	27249	22.12.2010
26290	13.12.2010	26380	04.12.2010	27245	08.12.2010	27251	29.12.2010
26291	13.12.2010	26507	28.12.2010	27246	19.12.2010	27273	08.12.2010
26314	29.12.2010						

**ND4Q Predĺženie platnosti zapísaných dizajnov**

(11) (51)  
 26408 16/06.01  
 26439 02/03.00

**7 (51) 02/03.00**  
**(11) 26439**  
 (15) 22.2.2002  
 (18) 16.8.2016  
 (21) 173-2001  
 (22) 16.8.2001  
 (73) Pivovary Staropramen a. s., Praha - Smíchov, CZ;  
**(54) Čiapka**

**7 (51) 16/06.01**  
**(11) 26408**  
 (15) 15.1.2002  
 (18) 22.6.2016  
 (21) 137-2001  
 (22) 22.6.2001  
 (73) UVEX ARBEITSSCHUTZ GMBH, Fürth, DE;  
**(54) Ochranné okuliare model "ultra sonic"**

(51) (11)  
 02/03.00 26439  
 16/06.01 26408

**TE4Q Zmeny adries**

**(11) 26744**  
 (21) 74-2003  
 (73) ROCKWOOL, a. s., Bohumín, CZ;  
 (58) 4.7.2011