

ČASŤ

DIZAJNY

Číselné INID - kódy na označovanie bibliografických údajov (Štandard WIPO ST. 80)

(11)	Číslo zapísaného dizajnu	(51)	Medzinárodné triedenie dizajnov
(15)	Dátum zápisu/predĺženia platnosti	(54)	Názov dizajnu
(18)	Predpokladaný dátum uplynutia platnosti zápisu/predĺženia platnosti	(55)	Vyobrazenie dizajnu/vyobrazenie dizajnu po čiastočnom výmaze
(21)	Číslo prihlášky	(58)	Dátum záznamu v registri, napr. zmeny mena, zániku, výmazu a pod.
(22)	Dátum podania prihlášky	(62)	Číslo pôvodnej prihlášky v prípade vylúčenej prihlášky
(24)	Dátum nadobudnutia účinkov zapísaného dizajnu	(72)	Meno pôvodcu (-ov)
(28)	Počet dizajnov	(73)	Meno (názov) a adresa majiteľa (-ov)
(31)	Číslo prioritnej prihlášky	(74)	Meno (názov) a adresa zástupcu (-ov)
(32)	Dátum podania prioritnej prihlášky	(78)	Meno (názov) a adresa nového majiteľa (-ov) po prevode alebo prechode
(33)	Krajina alebo regionálna organizácia priority		
(45)	Dátum sprístupnenia zapísaného dizajnu		
(46)	Dátum uplynutia odkladu zverejnenia		

Poznámka:

Číslo uvádzané pred kódom (51) znamená verziu Medzinárodného triedenia dizajnov.

Kódy na označovanie záhlaví oznámení publikovaných vo Vestníku ÚPV SR (Štandard WIPO ST. 17)

FG4Q	Zapísané dizajny Zapísané dizajny s odloženým zverejnením Zverejnené zapísané dizajny po uplynutí doby odkladu zverejnenia
MA4Q	Zaniknuté zapísané dizajny vzdáním sa
MC4Q	Vymazané zapísané dizajny
MG4Q	Čiastočne vymazané zapísané dizajny
MK4Q	Zaniknuté zapísané dizajny uplynutím doby platnosti
ND4Q	Predĺženie platnosti zapísaných dizajnov
PC4Q	Prevody a prechody práv
PD4Q	Zmeny dispozičných práv na zapísané dizajny (zálohy)
PD4Q	Zmeny dispozičných práv na zapísané dizajny (ukončenie zálohov)
QB4Q	Licenčné zmluvy registrované
QC4Q	Ukončenie platnosti licenčných zmlúv
TA4Q	Doplnenie pôvodcu (-ov)
TB4Q	Opravy mien
TC4Q	Zmeny mien
TD4Q	Opravy adries
TE4Q	Zmeny adries
TF4Q	Opravy dátumov
TG4Q	Opravy zatriedenia podľa Medzinárodného triedenia dizajnov
TH4Q	Opravy chýb alebo zmeny všeobecne
TK4Q	Opravy tlačových chýb vo Vestníku ÚPV SR

FG4Q

Zapísané dizajny

(11) (51)

27697 26/06.00

27698 25/01.08

9 (51) 25/01.08**(11) 27698**

(15) 28.1.2011

(18) 27.10.2015

(21) 64-2010

(22) 27.10.2010

(24) 28.1.2011

(72) Lupták Ján, Ing., Zvolen, SK;

(73) Lupták Ján, Ing., Zvolen, SK;

(54) Hliníkové profily, kolieska a príslušenstvo na výrobu dverí pre vstavané skrine

Určenie výrobku:

Výrobky stelesnené v prihlasovaných dizajnoch sú určené najmä ako dverové konštrukčné profily pre vstavané skrine.

(28) 74

(55)



1.1



2.1

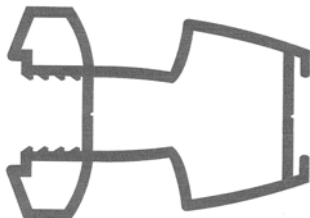

3.1

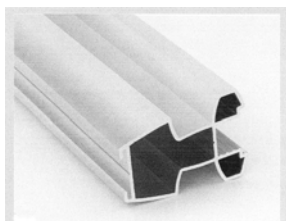

3.2

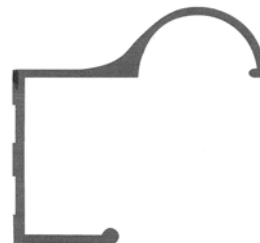

4.1

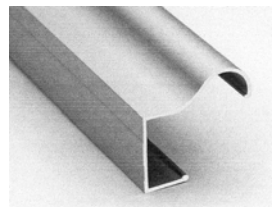

4.2

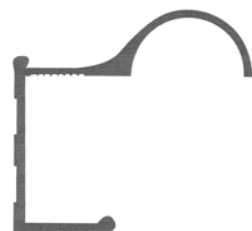

5.1

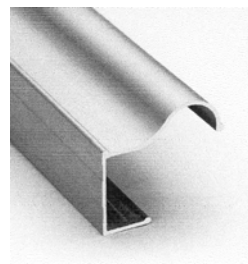

5.2

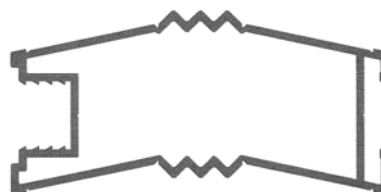

6.1

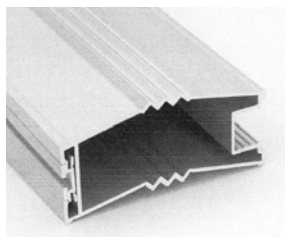

6.2

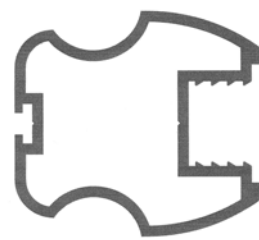

9.1

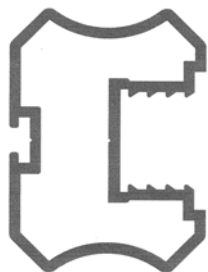

7.1

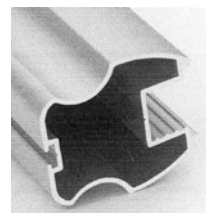

9.2

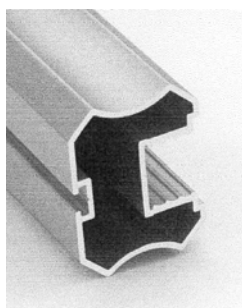

7.2



10.1

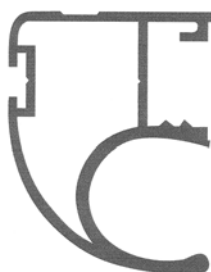

8.1

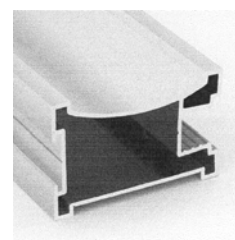

10.2

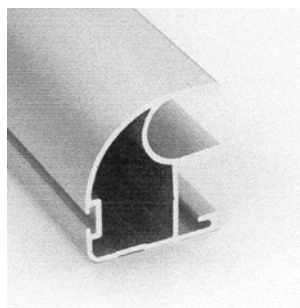

8.2

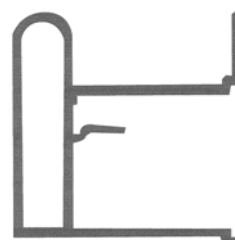

11.1

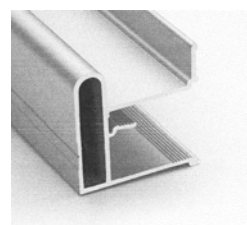

11.2



12.1

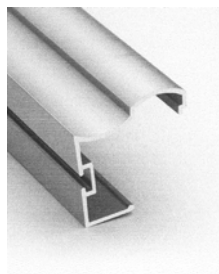

12.2

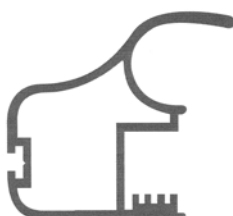

13.1

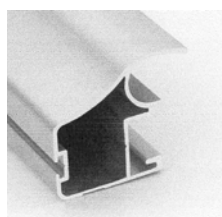

13.2



14.1



15.1

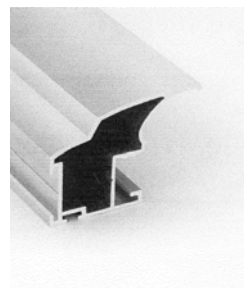

15.2

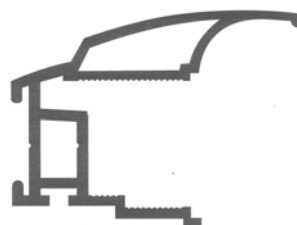

16.1

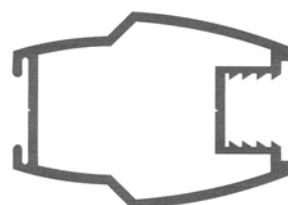

17.1

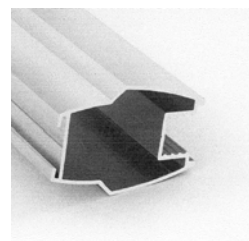

17.2

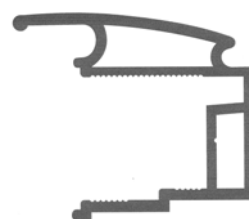

18.1

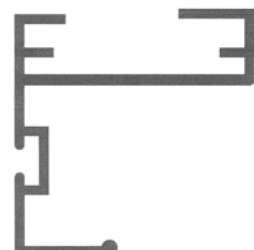

19.1

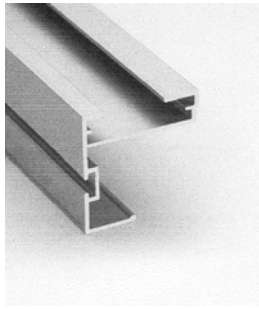

19.2

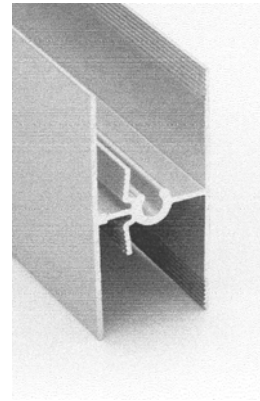

22.2

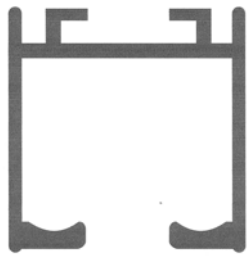

20.1



23.1

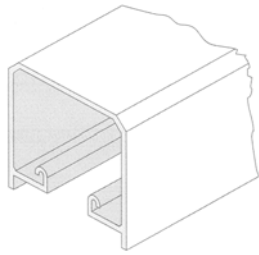

21.1

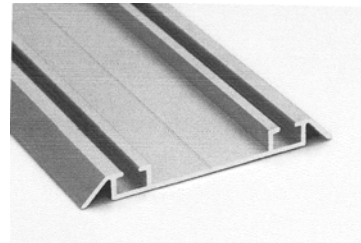

23.2



24.1

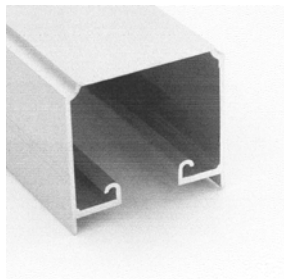

21.2

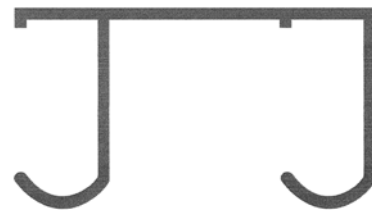

25.1

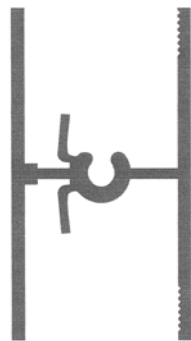

22.1

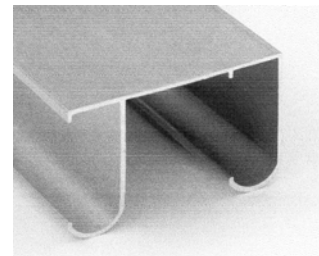

25.2



26.1

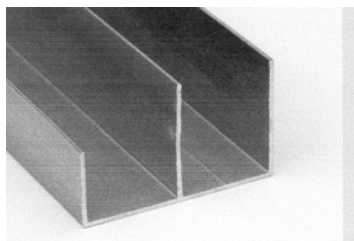

26.2

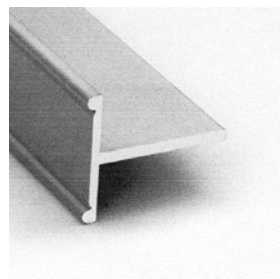

29.2

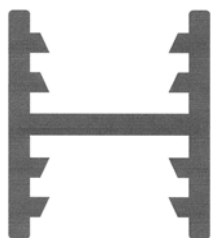

27.1

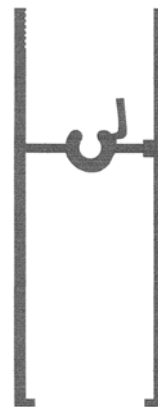

30.1

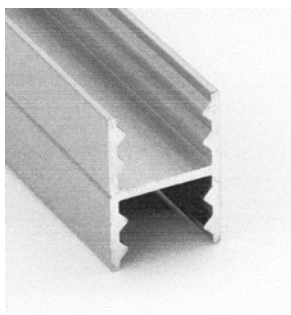

27.2

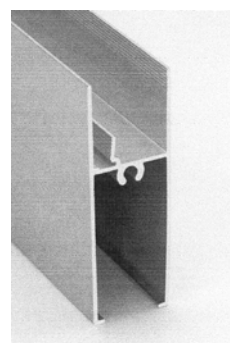

30.2

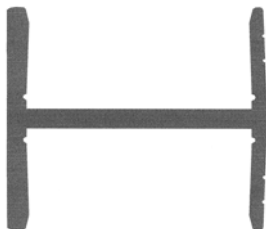

28.1

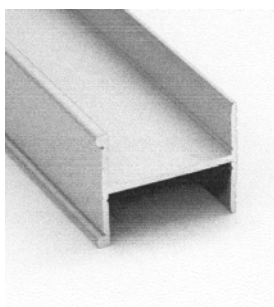

28.2

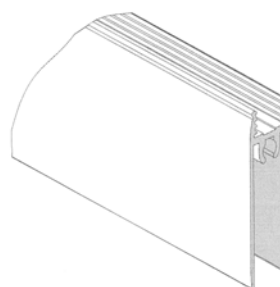

31.1

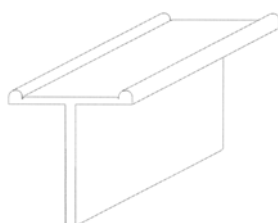

29.1

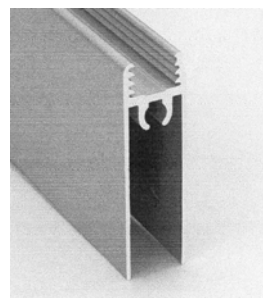

31.2

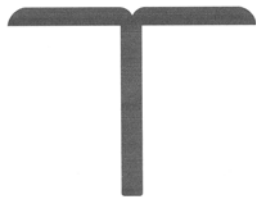

32.1

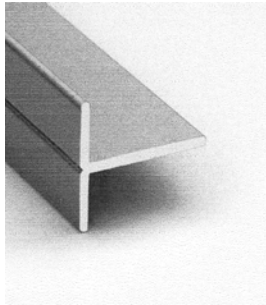

32.2

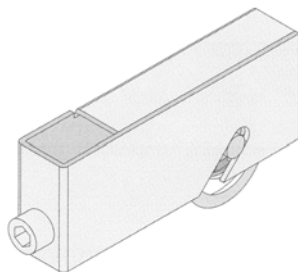

33.1

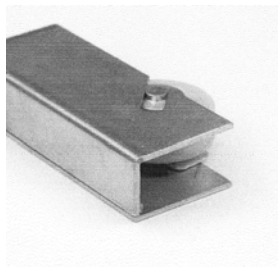

33.2

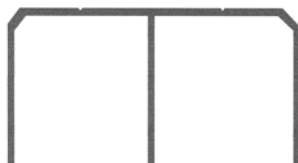

34.1

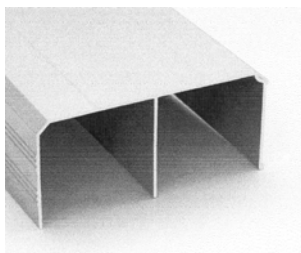

34.2



35.1

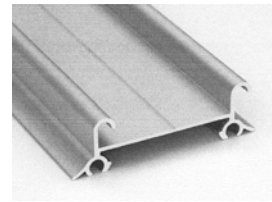

35.2



36.1

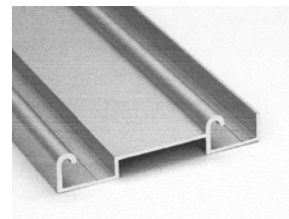

36.2

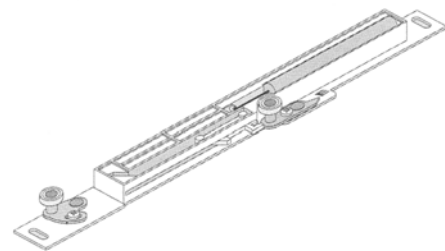

37.1

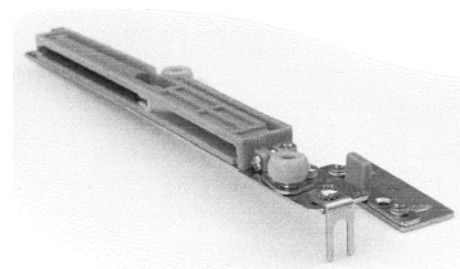

37.2

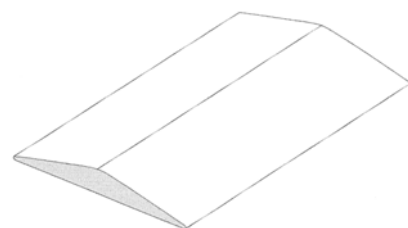

38.1

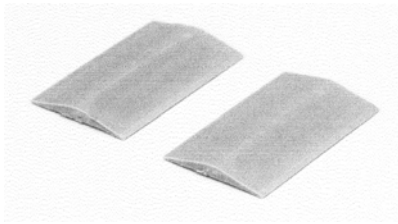

38.2

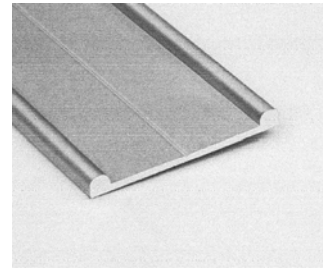

41.2

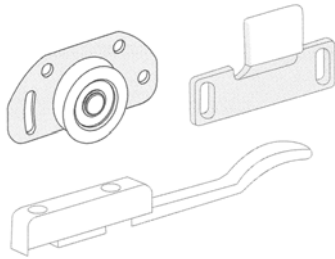

39.1

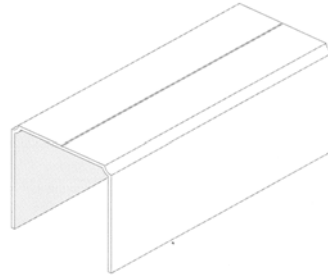

42.1

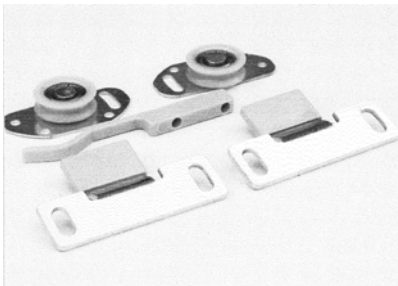

39.2



43.1

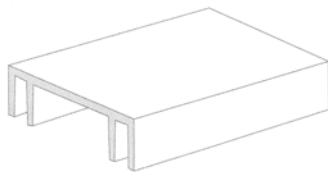

40.1

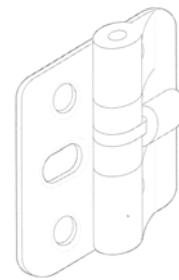

44.1

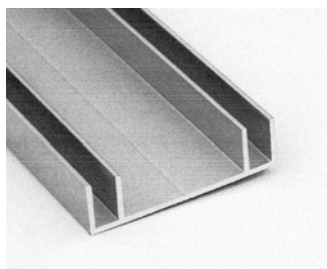

40.2

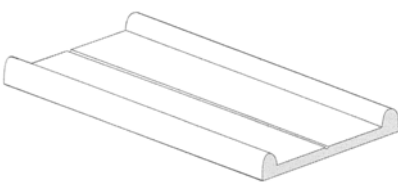

41.1

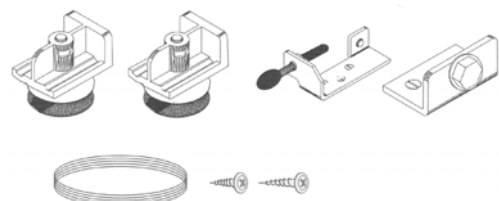

45.1

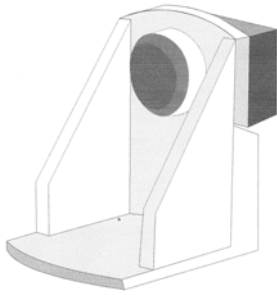

46.1

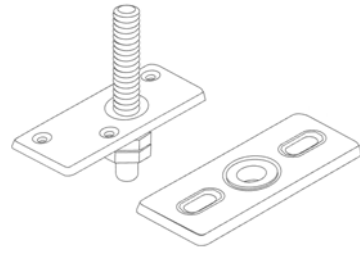

51.1

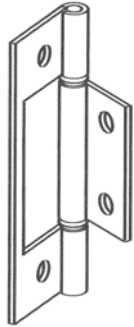

47.1

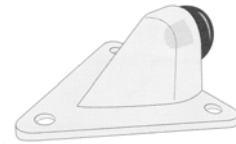

52.1



52.2

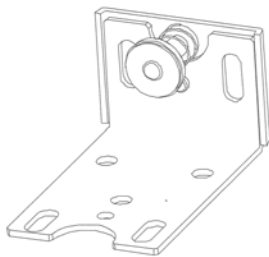

48.1

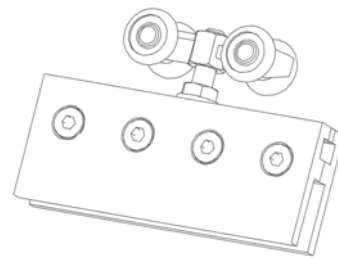

53.1

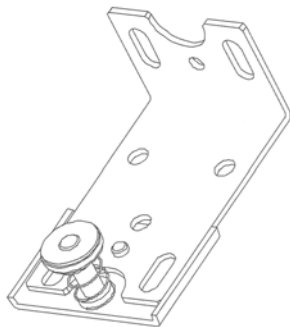

49.1

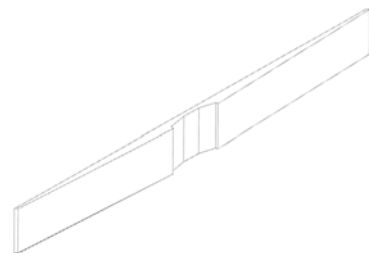

54.1

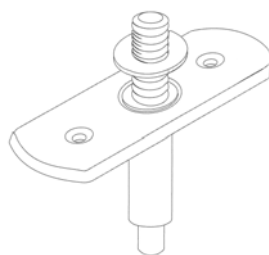

50.1

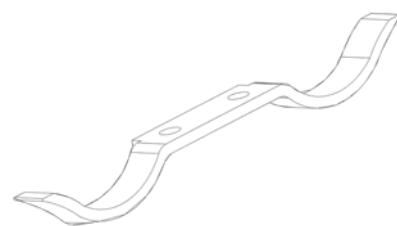

55.1

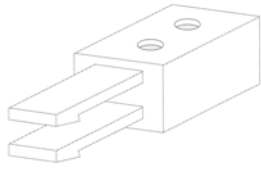

56.1

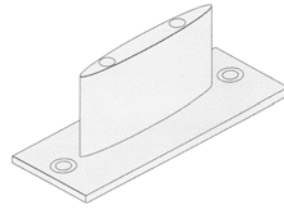

59.1

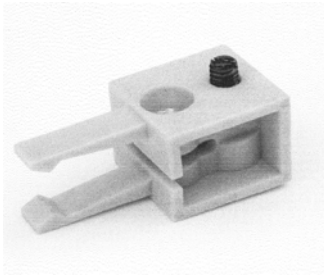

56.2

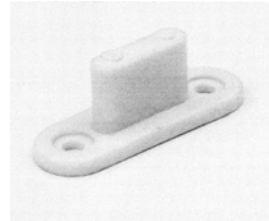

59.2

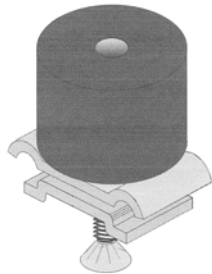

57.1

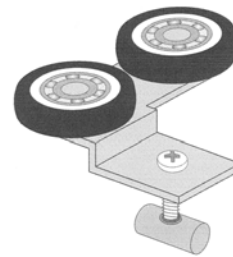

60.1



57.2



60.2

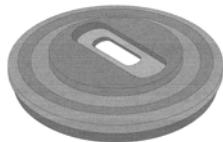

58.1



61.1



58.2

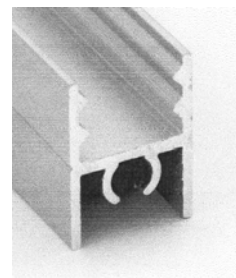

61.2

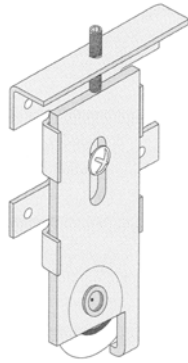

62.1

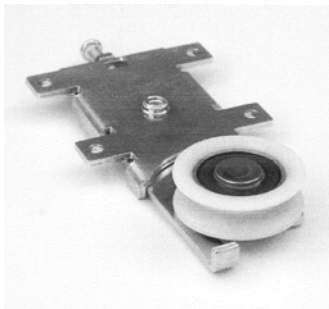

62.2

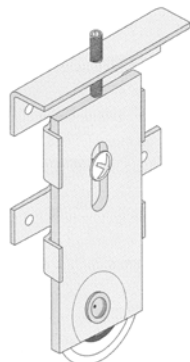

63.1

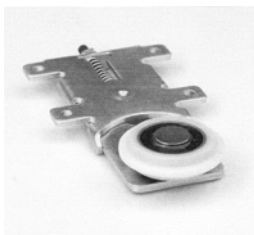

63.2

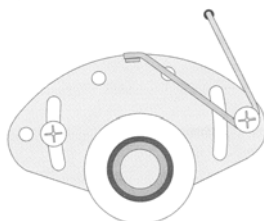

64.1

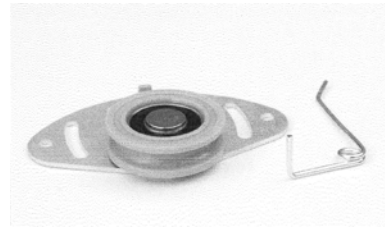

64.2

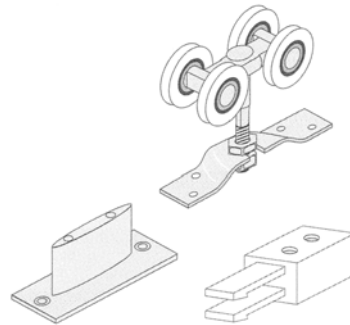

65.1

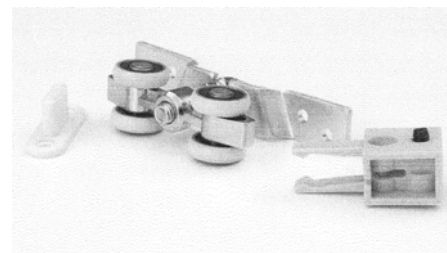

65.2

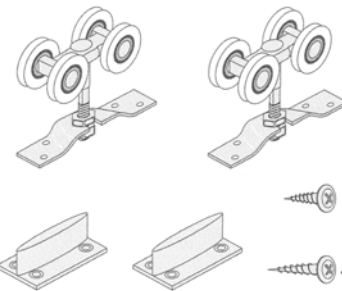

66.1

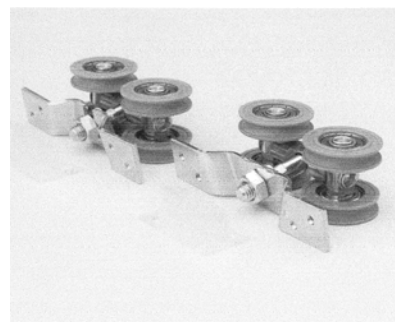

66.2

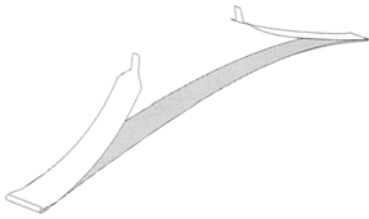

67.1

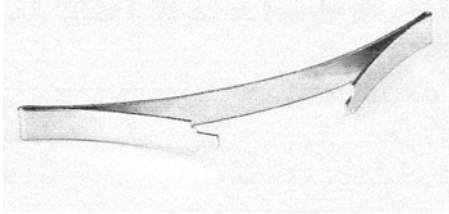

67.2



68.1

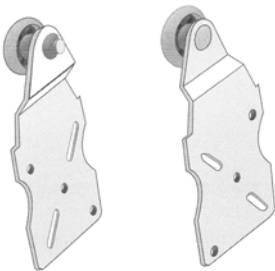

69.1

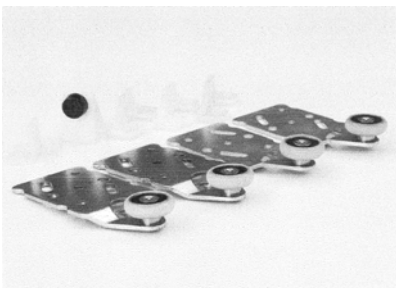

69.2



70.1

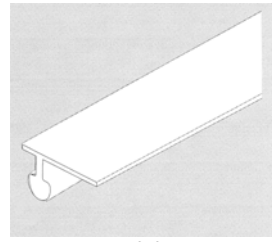

70.2

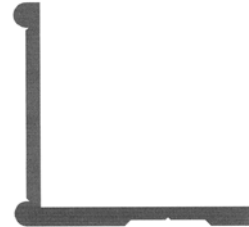

71.1

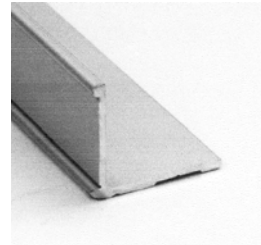

71.2

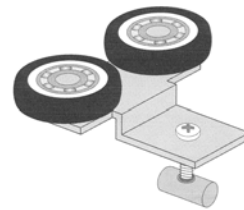

72.1

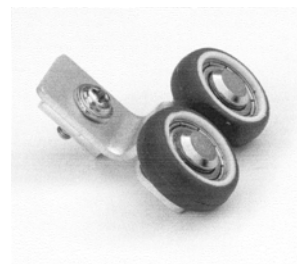

72.2

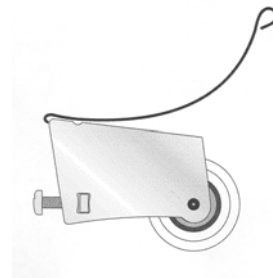

73.1

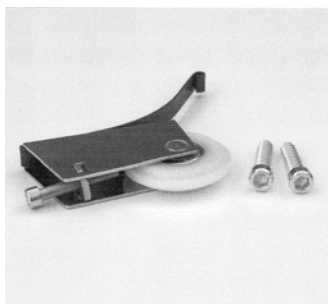

73.2

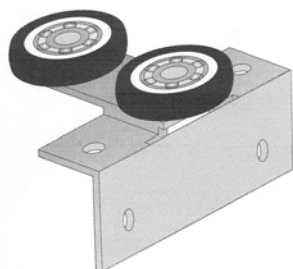

74.1



74.2



1.2



1.3



1.4



1.5

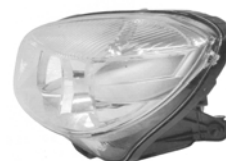

1.6



2.1



1.1

9 (51) 26/06.00

(11) 27697

(15) 3.1.2011

(18) 30.8.2015

(21) 5009-2010

(22) 30.8.2010

(24) 3.1.2011

(31) Pvz 2010-38105

(32) 2.3.2010

(33) CZ

(72) Manske Jens, Mladá Boleslav, CZ;

(73) ŠKODA AUTO a. s., Mladá Boleslav, CZ;

(74) ROTT, RŮŽIČKA & GUTTMANN, Bratislava, SK;

(54) Svetelné vybavenie vozidla

Určenie výrobku:

Výrobky, v ktorých budú dizajny stelesnené, sú svetlomety a svetidlá vozidla.

(28) 10

(55)



2.2



3.1



2.3



3.2



2.4



3.3



2.5



3.4



2.6



3.5

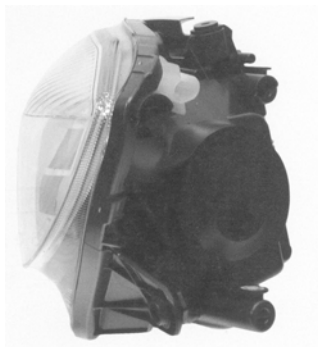

3.6



4.5



4.1

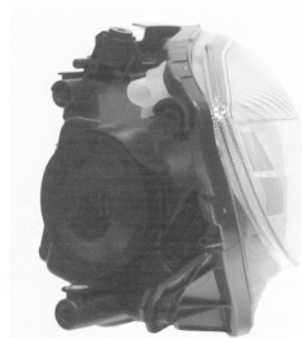

4.6



4.2
4.2



5.1



4.3



5.2



4.4



5.3



5.4



6.3



5.5



6.4



5.6



6.5



6.1

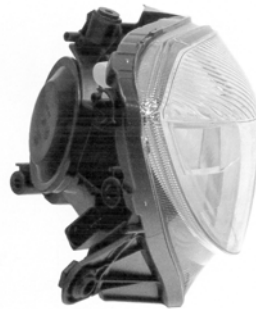

6.6



6.2



7.1



7.2



8.1

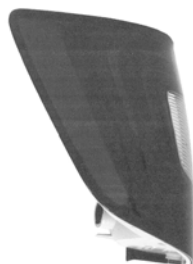

7.3

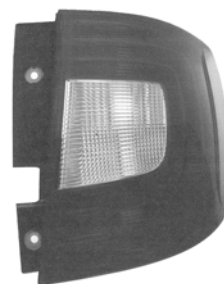

8.2

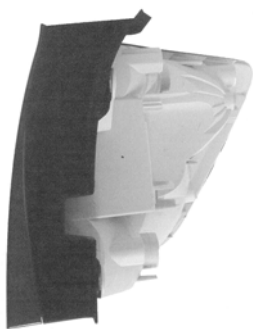

7.4



8.3

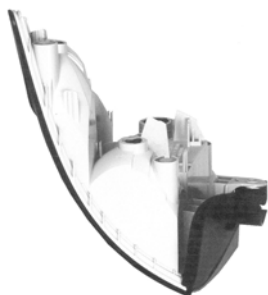

7.5

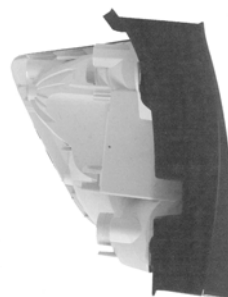

8.4



7.6



8.5



8.6



9.5



9.1



10.1



9.2



10.2

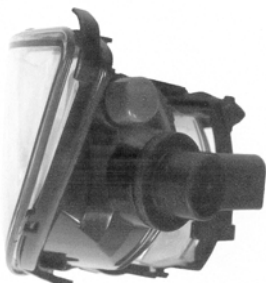

9.3



10.3



9.4



10.4



10.5

(51)	(11)
25/01.08	27698
26/06.00	27697

MK4Q Zaniknuté zapísané dizajny uplynutím doby platnosti

(11)	Dátum zániku	(11)	Dátum zániku	(11)	Dátum zániku	(11)	Dátum zániku
25058	04.01.2011	26170	26.06.2010	26287	22.06.2010	27187	09.06.2010
25063	23.01.2011	26179	07.06.2010	27185	06.06.2010	27192	06.06.2010
26163	13.06.2010	26217	16.06.2010	27186	06.06.2010		

ND4Q Predĺženie platnosti zapísaných dizajnov

(11)	(51)	(11)	(51)	(11)	(51)	(11)	(51)
26239	16/99.00	26321	05/06.00	26339	05/06.00	27238	09/01.01
26271	24/02.04	26322	05/06.00	27215	02/02.04	27292	09/05.08
26320	05/06.00						

8 (51) 02/02.04, 02/03.00**(11) 27215**

(15) 24.3.2006

(18) 23.1.2016

(21) 4-2006

(22) 23.1.2006

(73) ZEKON, a. s., Michalovce, SK;

(54) Univerzálna rovnošata poľná

Určenie výrobku:

Výrobkom, ktorým je dizajn stelesnený, je bojový odev určený pre armádu s využitím pri usku-
točňovaní bojových, ale aj mierových zákrokov.**7 (51) 05/06.00****(11) 26320**

(15) 21.8.2001

(18) 1.3.2016

(21) 42-2001

(22) 1.3.2001

(73) Blizniak Peter, Ing., Košťany nad Turcom, SK;

(54) Biela svetloodrazová fólia registračných značiek IV**7 (51) 05/06.00****(11) 26321**

(15) 21.8.2001

(18) 1.3.2016

(21) 43-2001

(22) 1.3.2001

(73) Blizniak Peter, Ing., Košťany nad Turcom, SK;

(54) Biela svetloodrazová fólia registračných značiek II**7 (51) 05/06.00****(11) 26322**

(15) 22.8.2001

(18) 1.3.2016

(21) 44-2001

(22) 1.3.2001

(73) Blizniak Peter, Ing., Košťany nad Turcom, SK;

(54) Biela svetloodrazová fólia registračných značiek III**7 (51) 05/06.00, 12/99.00****(11) 26339**

(15) 21.9.2001

(18) 15.2.2016

(21) 29-2001

(22) 15.2.2001

(73) Blizniak Peter, Ing., Košťany nad Turcom, SK;

(54) Biela svetloodrazová fólia registračných značiek**8 (51) 09/01.01****(11) 27238**

(15) 24.5.2006

(18) 9.11.2015

(21) 101-2005

(22) 9.11.2005

(73) HENDY s.r.o., Banská Bystrica, SK;

(54) Nový tvar sklenenej a pet fľaše

Určenie výrobku:

Výrobky, v ktorých je dizajn stelesnený, sú sklenené alebo PET fľaše určené na plnenie pramenných vôd a ostatných nealkonápojov s objemom 0,25 l až 2,5 l.

- 8 (51) 09/05.08**
(11) 27292
 (15) 27.9.2006
 (18) 23.11.2015
 (21) 5022-2005
 (22) 23.11.2005
 (73) Chupek Milan, MUDr., Žilina, SK; Kyša Marián, Žilina, SK;
(54) Obal na diagnostický prostriedok
 Určenie výrobku:
 Výrobok, v ktorom je alebo bude dizajn stelesnený, je obal na diagnostický prostriedok a/alebo potlač obalu na diagnostický prostriedok, predovšetkým na tehotenský test.

- 7 (51) 24/02.04**
(11) 26271
 (15) 15.5.2001
 (18) 24.11.2015
 (21) 236-2000
 (22) 24.11.2000
 (73) Glaxo Group Limited, Greenford, Middlesex, GB;
(54) Injekčná striekačka

- 7 (51) 16/99.00**
(11) 26239
 (15) 20.4.2001
 (18) 17.10.2015
 (21) 211-2000
 (22) 17.10.2000
 (73) I. P. C. REFRACTORIES, spol. s r. o., Košice, SK;
(54) Dopadová doska so sférickým povrchom

(51)	(11)	(51)	(11)	(51)	(11)	(51)	(11)
02/02.04	27215	05/06.00	26322	09/01.01	27238	16/99.00	26239
05/06.00	26321	05/06.00	26339	09/05.08	27292	24/02.04	26271
05/06.00	26320						

PC4Q

Prevody a prechody práv

- (11) 26271**
 (21) 236-2000
 (78) Glaxo Group Limited, Greenford, Middlesex, GB;
 Predchádzajúci majiteľ:
 SANOFI-AVENTIS, Paris, FR;
 Dátum uzavretia zmluvy: 6.8.2009
 (58) 14.1.2011

- (11) 27237**
 (21) 98-2005
 (78) Jozef Hanuš INMAT, Solčany, SK;
 Predchádzajúci majiteľ:
 Sepro, spol. s r. o., Bratislava, SK;
 Dátum uzavretia zmluvy: 20.10.2010
 (58) 27.1.2011

TC4Q

Zmeny mien

- (11) 26271**
 (21) 236-2000
 (73) Glaxo Group Limited, Greenford, Middlesex, GB;
 (58) 14.1.2011