

**ČASŤ**

**DIZAJNY**

### Číselné INID - kódy na označovanie bibliografických údajov (Štandard WIPO ST. 80)

(11)	Číslo zapísaného dizajnu	(51)	Medzinárodné triedenie dizajnov
(15)	Dátum zápisu/predĺženia platnosti	(54)	Názov dizajnu
(18)	Predpokladaný dátum uplynutia platnosti zápisu/predĺženia platnosti	(55)	Vyobrazenie dizajnu/vyobrazenie dizajnu po čiastočnom výmaze
(21)	Číslo prihlášky	(58)	Dátum záznamu v registri, napr. zmeny mena, zániku, výmazu a pod.
(22)	Dátum podania prihlášky	(62)	Číslo pôvodnej prihlášky v prípade vylúčenej prihlášky
(24)	Dátum nadobudnutia účinkov zapísaného dizajnu	(71)	Meno (názov) a adresa prihlasovateľa (-ov)
(31)	Číslo prioritnej prihlášky	(72)	Meno pôvodcu (-ov)
(32)	Dátum podania prioritnej prihlášky	(73)	Meno (názov) a adresa majiteľa (-ov)
(33)	Krajina alebo regionálna organizácia priority	(74)	Meno (názov) a adresa zástupcu (-ov)
(45)	Dátum sprístupnenia zapísaného dizajnu	(78)	Meno (názov) a adresa nového majiteľa (-ov) po prevode alebo prechode
(46)	Dátum uplynutia odkladu zverejnenia		

Poznámka:

Číslo uvádzané pred kódom (51) znamená verziu Medzinárodného triedenia dizajnov.

### Kódy na označovanie záhlaví oznámení publikovaných vo Vestníku ÚPV SR (Štandard WIPO ST. 17)

<b>FG4Q</b>	Zapísané dizajny Zapísané dizajny s odloženým zverejnením Zverejnené zapísané dizajny po uplynutí doby odkladu zverejnenia
<b>MA4Q</b>	Zaniknuté zapísané dizajny vzdaním sa
<b>MC4Q</b>	Vymazané zapísané dizajny
<b>MG4Q</b>	Čiastočne vymazané zapísané dizajny
<b>MK4Q</b>	Zaniknuté zapísané dizajny uplynutím doby platnosti
<b>MM4Q</b>	Zaniknuté zapísané dizajny pre nezaplatenie poplatkov za predĺženie platnosti
<b>ND4Q</b>	Predĺženie platnosti zapísaných dizajnov
<b>PC4Q</b>	Prevody a prechody práv
<b>PD4Q</b>	Zmeny dispozičných práv na zapísané dizajny (zálohy)
<b>PD4Q</b>	Zmeny dispozičných práv na zapísané dizajny (ukončenie záloh)
<b>QB4Q</b>	Licenčné zmluvy registrované
<b>QC4Q</b>	Ukončenie platnosti licenčných zmlúv
<b>TA4Q</b>	Doplnenie meno pôvodcu (-ov)
<b>TB4Q</b>	Opravy mien
<b>TC4Q</b>	Zmeny mien
<b>TD4Q</b>	Opravy adries
<b>TE4Q</b>	Zmeny adries
<b>TF4Q</b>	Opravy dátumov
<b>TG4Q</b>	Opravy medzinárodného triedenia
<b>TH4Q</b>	Opravy chýb alebo zmeny všeobecne
<b>TK4Q</b>	Opravy tlačových chýb vo Vestníku ÚPV SR

## FG4Q

## Zapísané dizajny

(11)	(51)	(11)	(51)	(11)	(51)	(11)	(51)
27092	19/04.02	27095	21/01.01	27098	13/03.01	27101	15/05.03
27093	09/02.03	27096	23/02.11	27099	13/03.03		
27094	02/02.04	27097	21/01.02	27100	13/03.03		

**8 (51) 02/02.04****(11) 27094**

- (15) 12.5.2005
- (18) 21.10.2009
- (21) 175-2004
- (22) 21.10.2004
- (24) 12.5.2005

- (72) Oravec Ján, Prievidza, SK;
- (73) VEP, spol. s r. o., Bojnice, SK;
- (74) Kubínyi Peter, Bc., Trenčín, SK;

**(54) Vesta**

Určenie výrobku: Výrobok, v ktorom je dizajn stelesnený, slúži na uloženie a prenos výstroje a výzbroje bezpečnostných a špeciálnych zásahových zložiek.

- (28) 1
- (55)



1.1



1.2

**(54) Nádoba na med**

Určenie výrobku: Výrobkom, v ktorom je dizajn stelesnený, je NÁDOBA NA MED, určená na skladovanie, stohovanie a transport medu.

- (28) 1
- (55)



1.1



1.2



1.3



1.4

**8 (51) 09/02.03****(11) 27093**

- (15) 12.5.2005
- (18) 30.9.2009
- (21) 172-2004
- (22) 30.9.2004
- (24) 12.5.2005

- (72) Peťo Miroslav, Ing., Košice, SK; Hajas Štefan, Ing., Košice, SK;
- (73) SEKON, s. r. o., Košice, SK;
- (74) Gruber Dalibor, Ing., Košice, SK;



1.5



1.6



1.7

**8 (51) 13/03.03**

**(11) 27099**

(15) 24.5.2005

(18) 15.11.2009

(21) 183-2004

(22) 15.11.2004

(24) 24.5.2005

(72) Gont Milan, Ing., Dolný Kubín, SK;

(73) SEZ, a. s., Dolný Kubín, SK;

**(54) Nástenná zásuvka kombinovaná**

Určenie výrobku: Nástenná zásuvka kombinovaná je určená na rozvod elektrickej energie z jedného prívodu do dvoch zásuviek rôznych typov. Okrem zásuviek môže obsahovať aj poistku.

(28) 2

(55) 2



1.1



2.1

**8 (51) 13/03.01**

**(11) 27098**

(15) 24.5.2005

(18) 15.11.2009

(21) 182-2004

(22) 15.11.2004

(24) 24.5.2005

(72) Hornáková Žofia, Dolný Kubín, SK;

(73) SEZ, a. s., Dolný Kubín, SK;

**(54) Ekvipotenciálna svorkovnica**

Určenie výrobku: Ekvipotenciálna svorkovnica je určená na rozvod vodičov s rovnakým potenciálom v elektrickom obvode.

(28) 1

(55) 1



1.1

**8 (51) 13/03.03**

**(11) 27100**

(15) 24.5.2005

(18) 15.11.2009

(21) 184-2004

(22) 15.11.2004

(24) 24.5.2005

(72) Kysel Jozef, Ing., Istebné, SK;

(73) SEZ, a. s., Dolný Kubín, SK;

**(54) Domové spínače a zásuvky III**

Určenie výrobku: Domové spínače a zásuvky III sú určené na spínanie elektrickej energie a na rozvod elektrickej energie, na telefóny, televízny a rozhlasový rozvod.

(28) 5

(55) 5



1.1



2.1



3.1



4.1



5.1

(55)



1.1



1.2



1.3

8 (51) 15/05.03

(11) 27101

(15) 24.5.2005

(18) 20.12.2009

(21) 201-2004

(22) 20.12.2004

(24) 24.5.2005

(31) PVz 2004 -35393

(32) 29.6.2004

(33) CZ

(72) Dubák Vladimír, Tuchoměřice, CZ;

(73) DUNET s. r. o., Praha, CZ;

(74) Kubínyi Peter, Bc., Trenčín, SK;

**(54) Umývačka na ručné umývanie skla a nádoba umývačky**

Určenie výrobku: Výrobok, v ktorom je dizajn stelesnený, slúži na ručné umývanie skla, najmä pívneho skla.

(28) 2

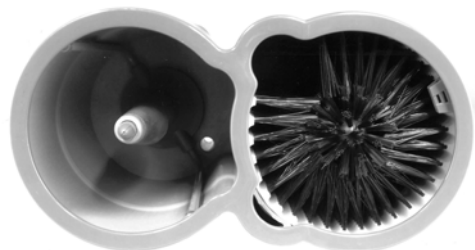

1.4



1.5

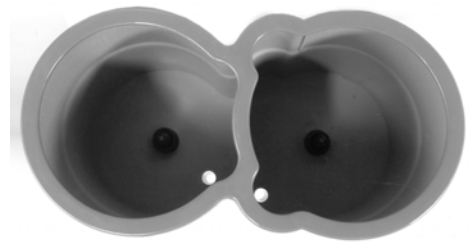

2.4



2.1



2.5

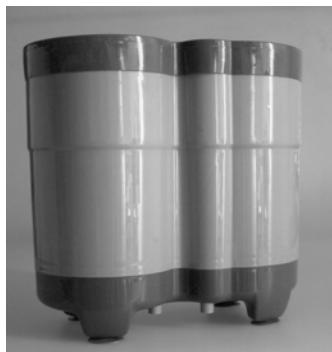

2.2



2.3

8 (51) 19/04.02

(11) 27092

(15) 11.5.2005

(18) 30.9.2009

(21) 171-2004

(22) 30.9.2004

(24) 11.5.2005

(72) HÚŠŤAVA Ladislav, Čebovce, SK;

(73) Ladislav HÚŠŤAVA LHprint, Čebovce, SK;

(74) Gruber Dalibor, Ing., Košice, SK;

(54) **Zápisník**

Určenie výrobku: Výrobkom, v ktorom je dizajn stelesnený, je päť variantov ZÁPISNÍKA, určených ako zapisovací pamätník pre maturantov.

(28) 5

(55)

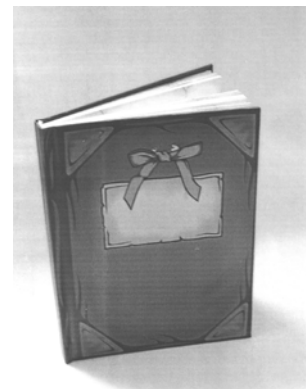

1.1

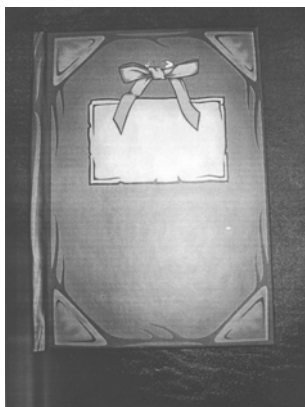

1.2

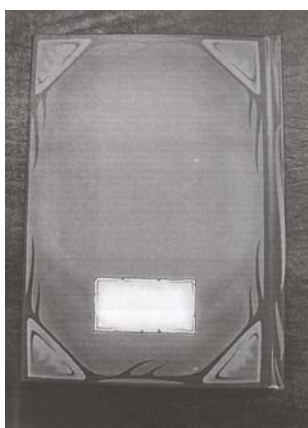

1.3



2.1



2.2

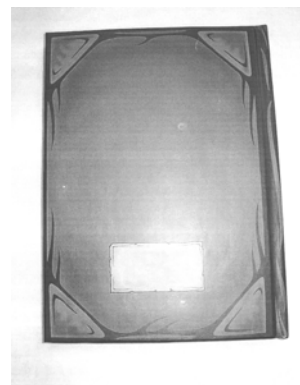

2.3



3.1

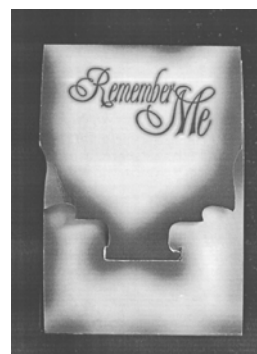

3.2



3.3



3.4

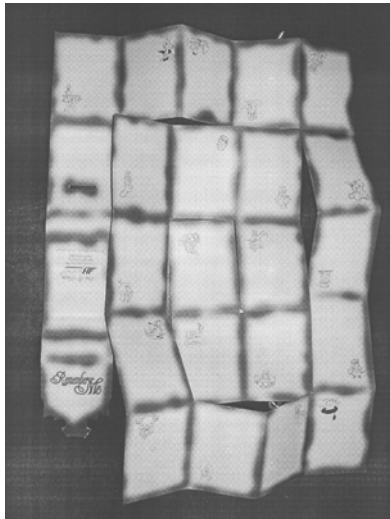

3.5

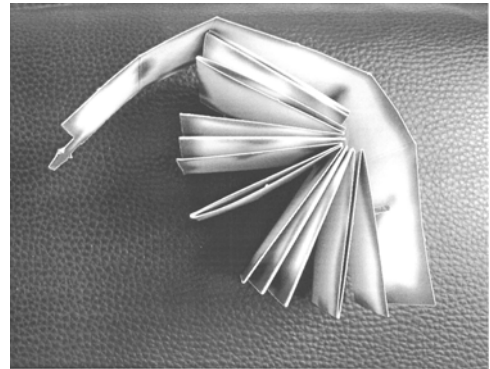

4.4



4.1

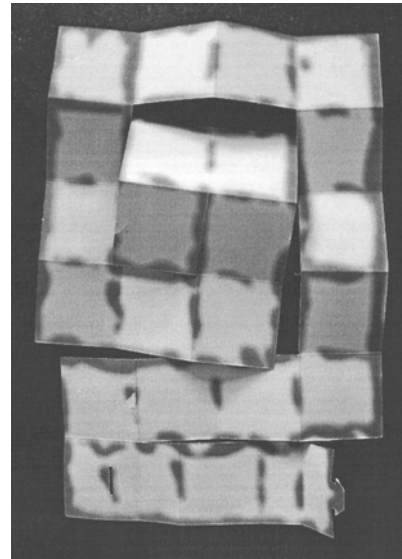

4.5

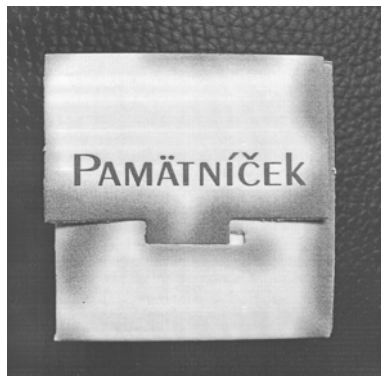

4.2



5.1



4.3

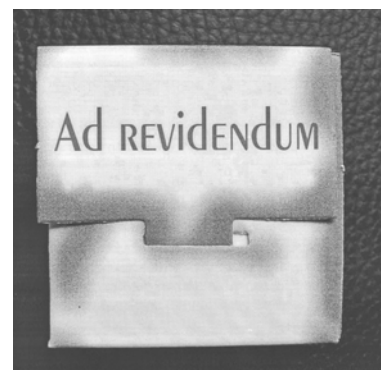

5.2





5.3

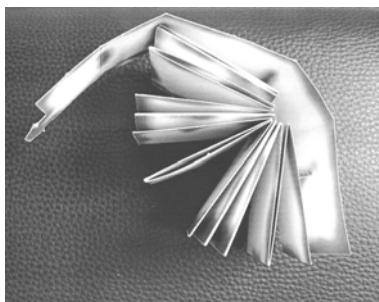

5.4

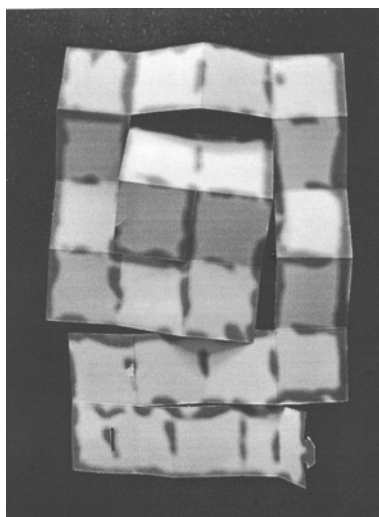

5.5

(55)

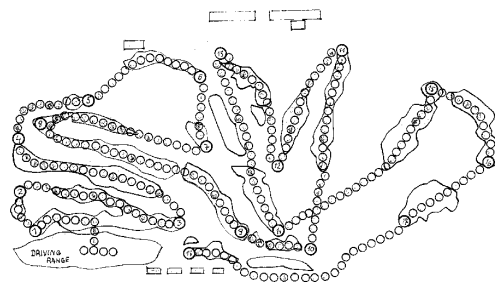

1.1

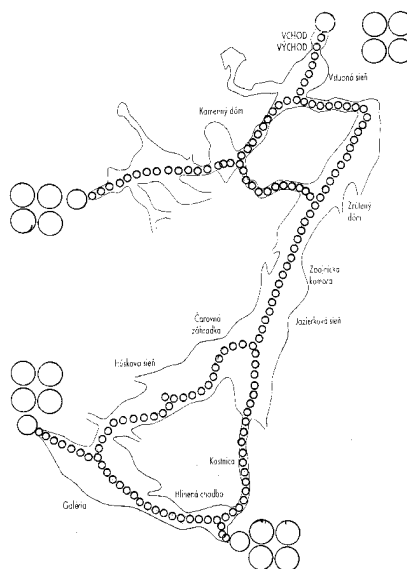

2.1

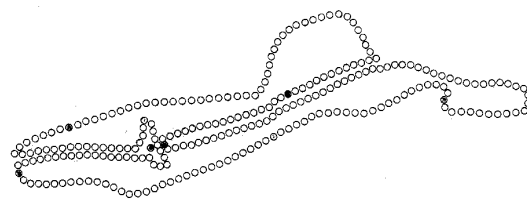

3.1



3.1

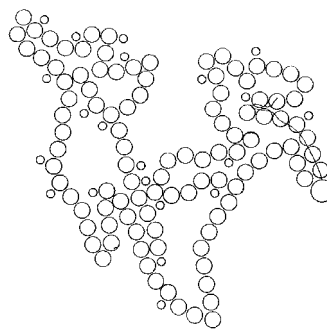

4.1

**8 (51) 21/01.01****(11) 27095**

(15) 24.5.2005

(18) 11.10.2009

(21) 174-2004

(22) 11.10.2004

(24) 24.5.2005

(72) Vicen Ján, Banská Bystrica, SK;

(73) Vicen Ján, Banská Bystrica, SK;

**(54) Spoločenská hra**

Určenie výrobku: Výrobok, v ktorom je dizajn stelesnený, je hrací plán spoločenskej hry, určený aj ako suvení, reklamné médium, informačné médium, školská potreba, produkt cestovného ruchu a turizmu, zábavná hra.

(28) 7

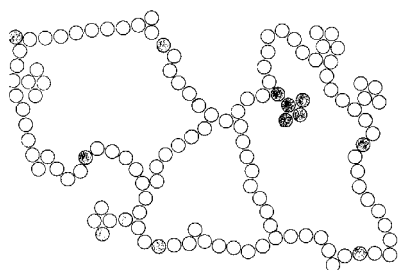

5.1

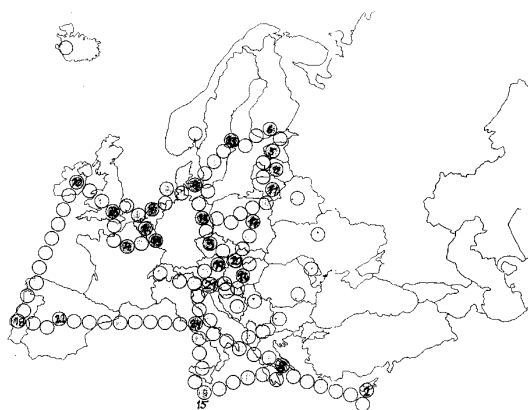

6.1

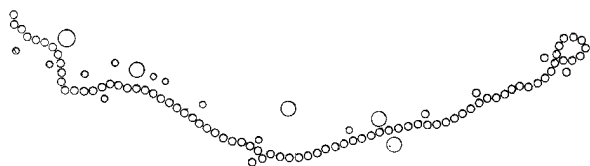

7.1

8 (51) 21/01.02

(11) 27097

(15) 24.5.2005

(18) 5.11.2009

(21) 177-2004

(22) 5.11.2004

(24) 24.5.2005

(72) Smith Mike, Cardiff, GB;

(73) JPM International Limited, Cardiff, GB;

(74) Holoubková Mária, Ing., Bratislava, SK;

(54) **Predný panel výherného automatu**

Určenie výrobku: Výrobok, v ktorom bude dizajn stelesnený, je určený ako predný panel výherného automatu, ako časť prístroja určeného na zábavu pri peňažných stávkach.

(28) 1

(55)



1.1

8 (51) 23/02.11

(11) 27096

(15) 24.5.2005

(18) 3.11.2009

(21) 176-2004

(22) 3.11.2004

(24) 24.5.2005

(72) Uhlík Jozef, Ing., Chtelnica, SK;

(73) Chirana Progress, s. r. o., Piešťany, SK;

(74) Beleščák Ladislav, Ing., Piešťany, SK;

(54) **Držiak masážnej hadice**

Určenie výrobku: Výrobok držiaka masážnej hadice, v ktorom je dizajn stelesnený alebo na ktorom je použitý, je určený na uloženie a uchytanie hadice masážneho zariadenia, najmä na vodnú masáž tela.

(28) 1

(55)

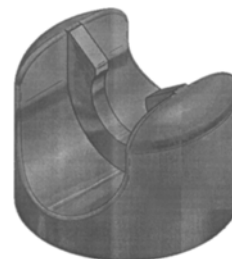

1.1



1.2

(51)

(11)

(51)

(11)

(51)

(11)

(51)

(11)

02/02.04

27094

13/03.03

27100

19/04.02

27092

23/02.11

27096

09/02.03

27093

13/03.03

27099

21/01.01

27095

13/03.01

27098

15/05.03

27101

21/01.02

27097

**FG4Q Zverejnené zapísané dizajny po uplynutí doby odkladu zverejnenia**

(11) (51)

26717 19/06.01

26742 03/01.12

**7 (51) 03/01.12****(11) 26742**

(45) 2.12.2003

(73) Šulek Anton, Bratislava, SK;

**(54) Magnetoplastový obal na vizitky**

Určenie výrobku: Výrobok, v ktorom bude dizajn stelesnený alebo na ktorom bude aplikovaný, je určený ako obal na ukladanie vizitiek.

(28) 35

Oznámenie o zápise dizajnu do registra vo Vestníku ÚPV SR č.: 12/2003

(55)

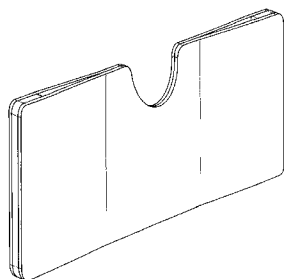

1.1

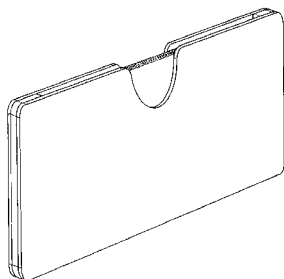

1.2

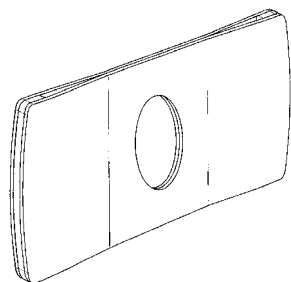

2.1

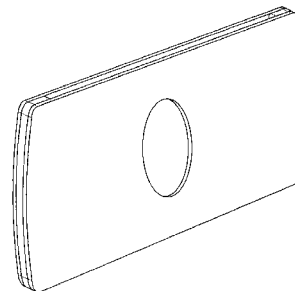

2.2

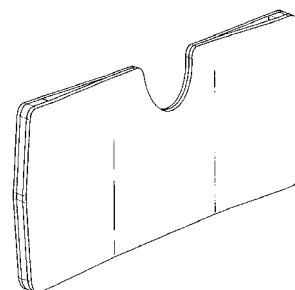

3.1

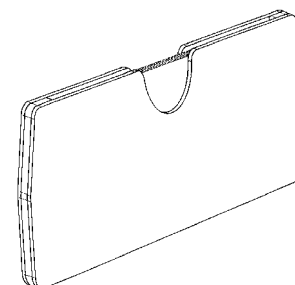

3.2

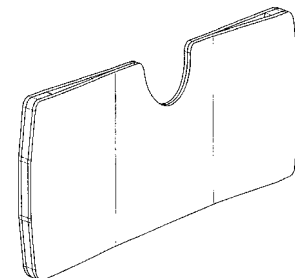

4.1

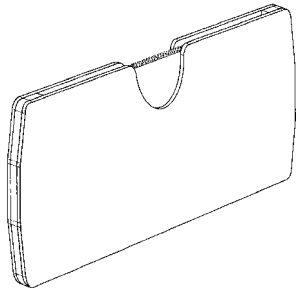

4.2

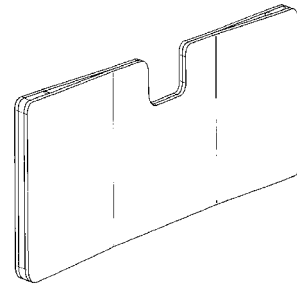

7.1

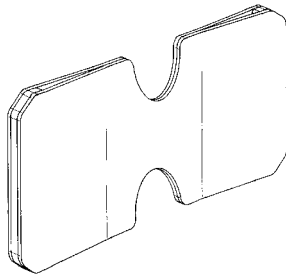

5.1

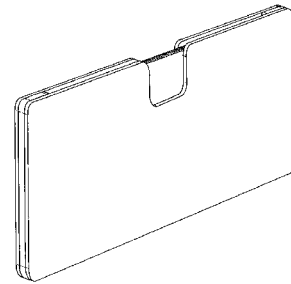

7.2

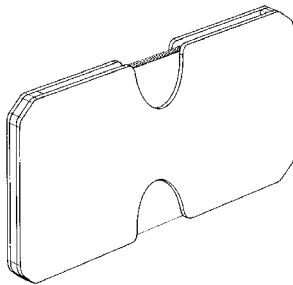

5.2

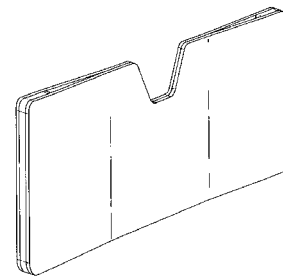

8.1

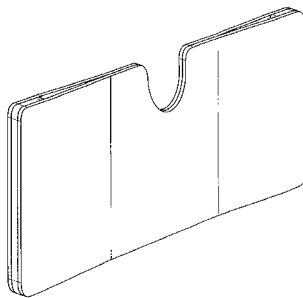

6.1

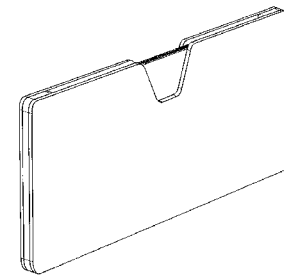

8.2

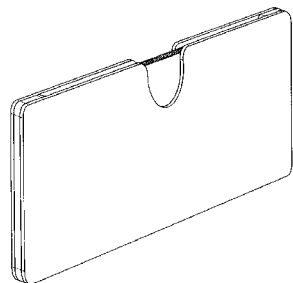

6.2

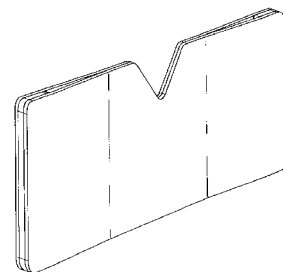

9.1

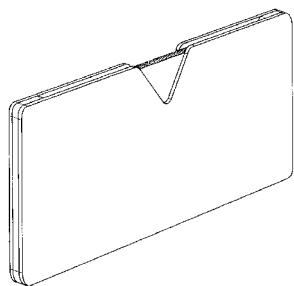

9.2

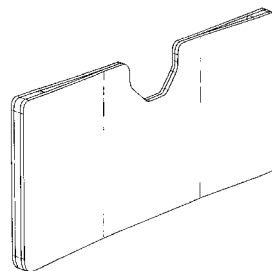

12.1

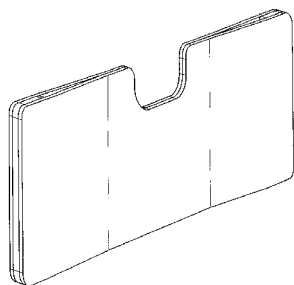

10.1

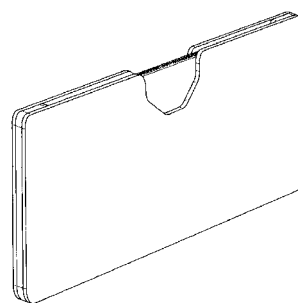

12.2

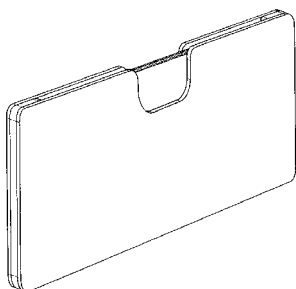

10.2

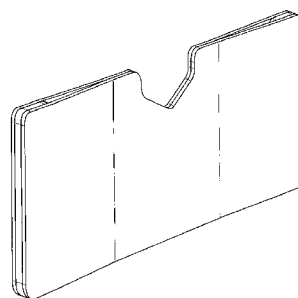

13.1

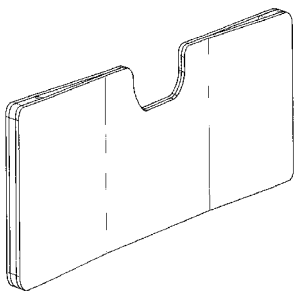

11.1

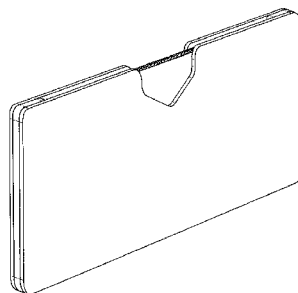

13.2

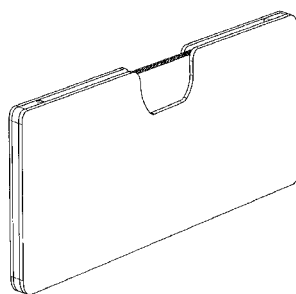

11.2

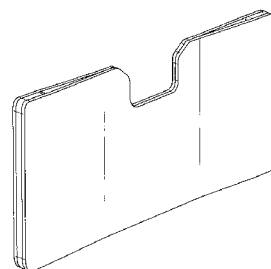

14.1

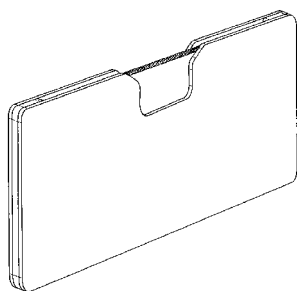

14.2

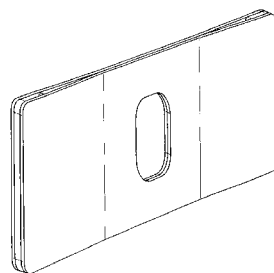

17.1

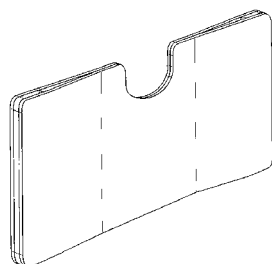

15.1

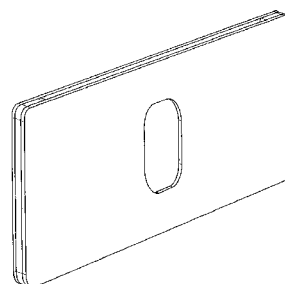

17.2

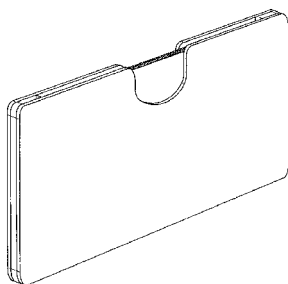

15.2

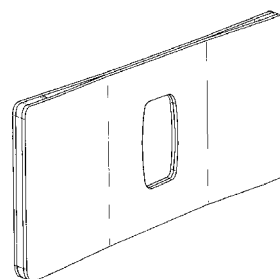

18.1

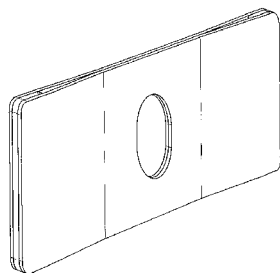

16.1

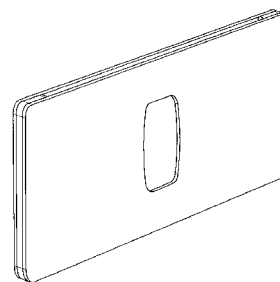

18.2

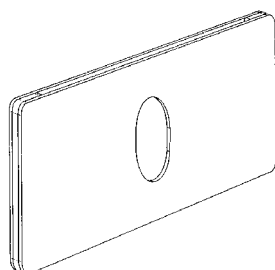

16.2

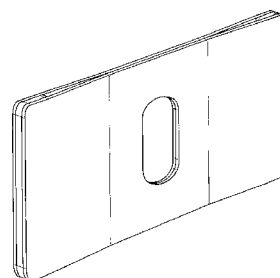

19.1

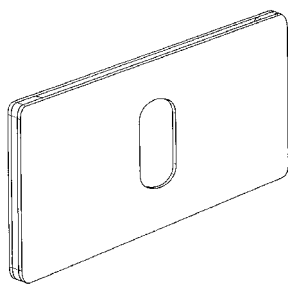

19.2

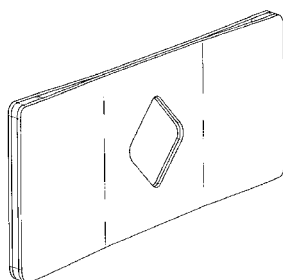

20.1

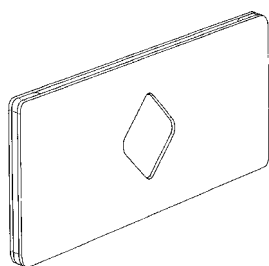

20.2

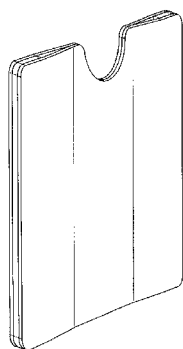

21.1

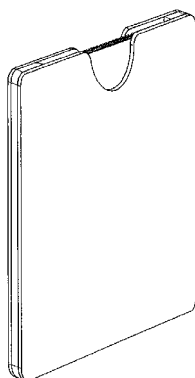

21.2

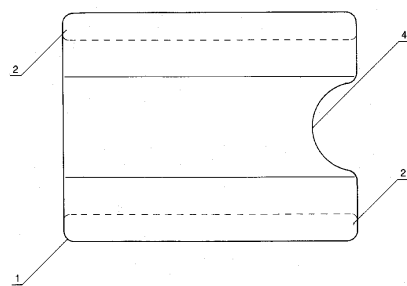

21.3

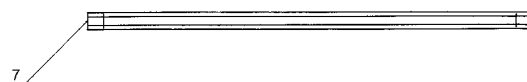

21.4



21.5

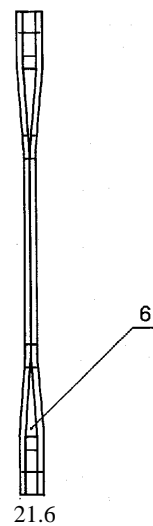

21.6

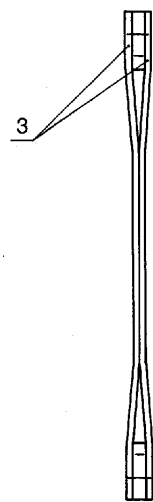

21.7

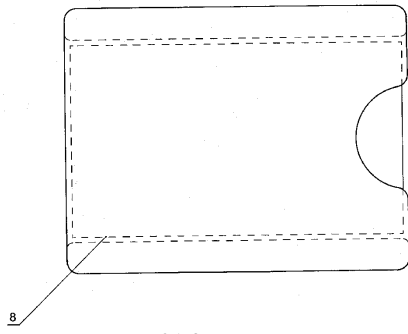

21.8



21.9

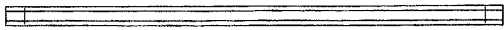

21.10



21.11



21.12

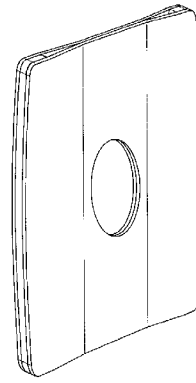

22.1

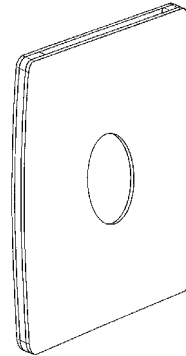

22.2

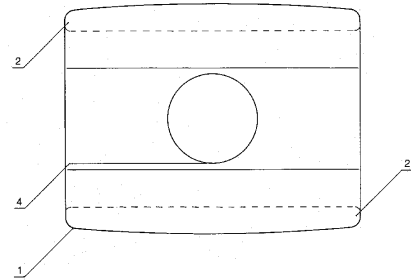

22.3



22.4

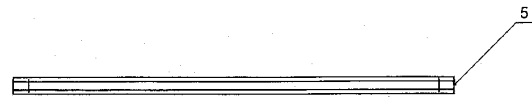

22.5



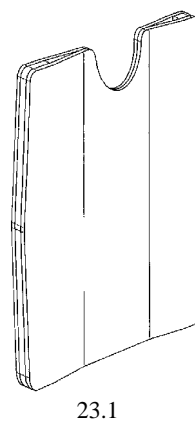
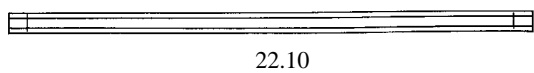
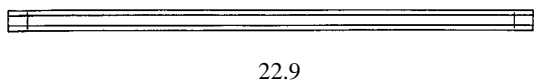
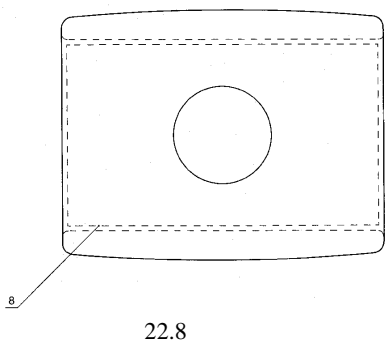
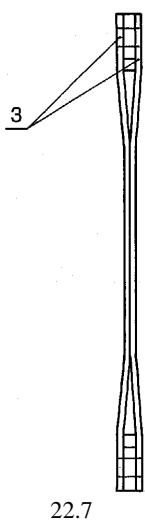
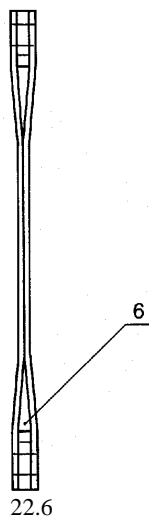

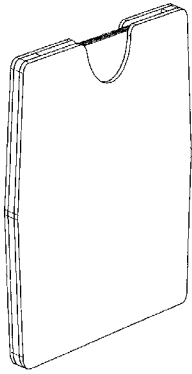

23.2

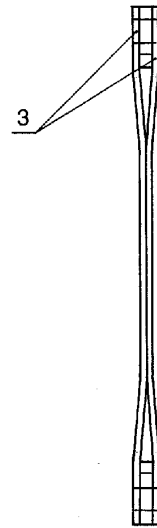

23.7

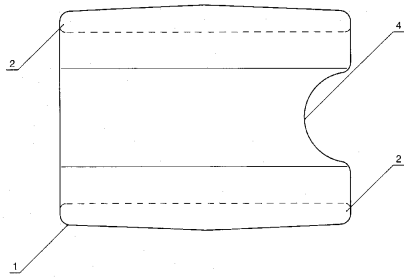

23.3

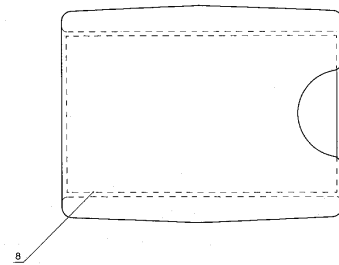

23.8



23.4

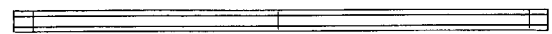

23.9

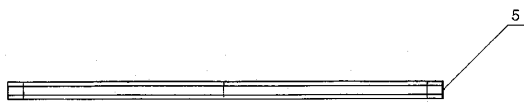

23.5

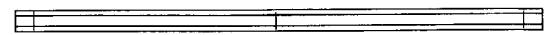

23.10

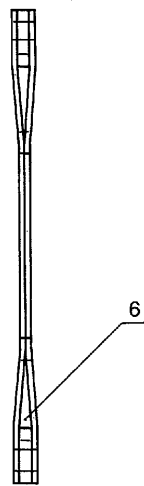

23.6



23.11



23.12

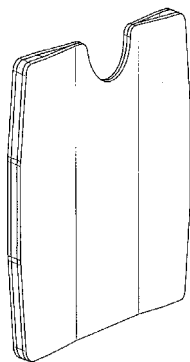

24.1

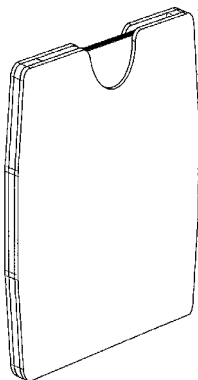

24.2

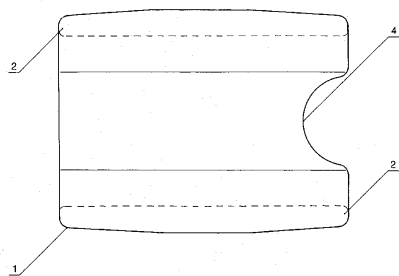

24.3

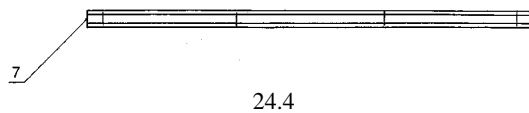

24.4

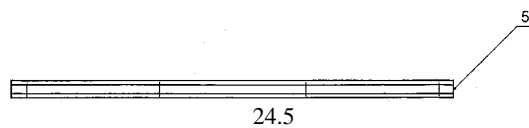

24.5



24.6

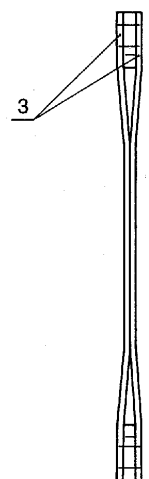

24.7

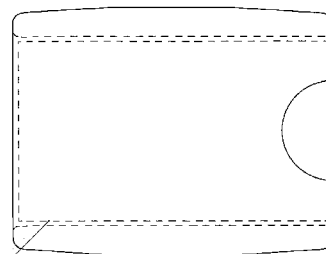

24.8

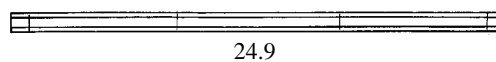

24.9

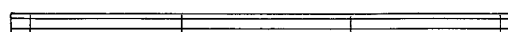

24.10



24.11



24.12

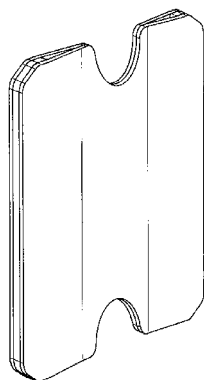

25.1

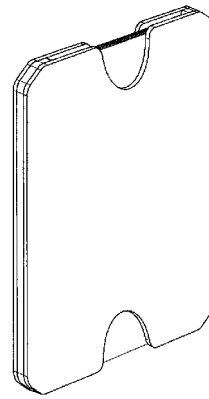

25.2

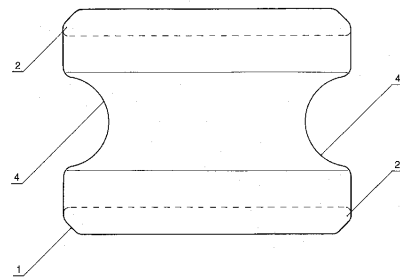

25.3

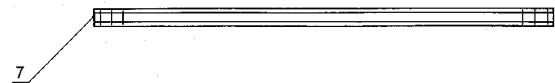

25.4

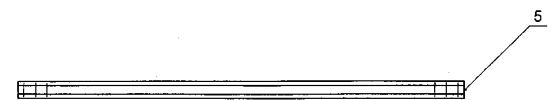

25.5



25.6

6

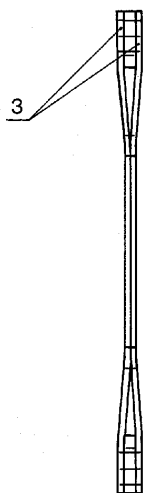

25.7



25.12

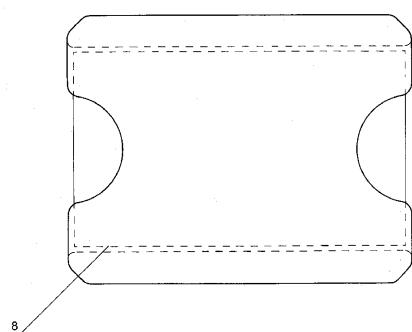

25.8



25.9

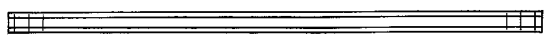

25.10



25.11

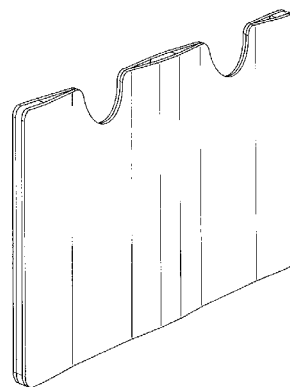

26.1

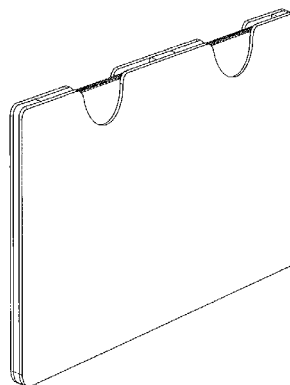

26.2

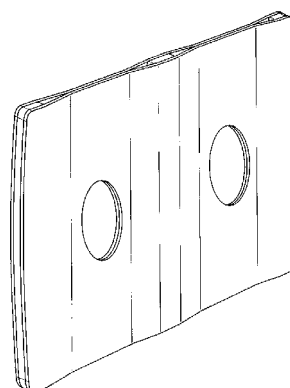

27.1

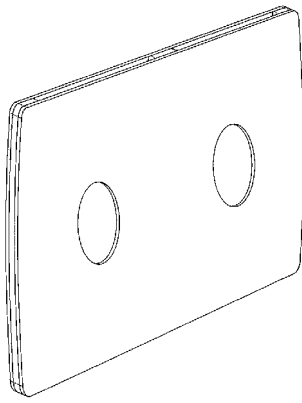

27.2

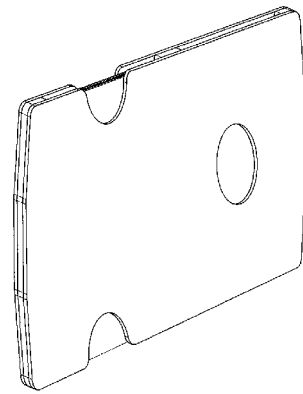

29.2

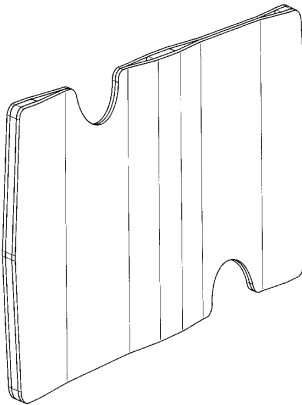

28.1

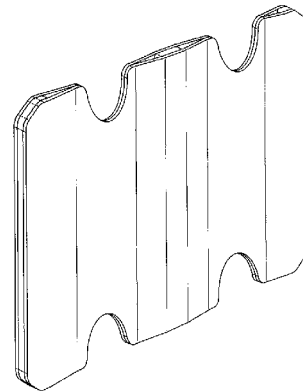

30.1

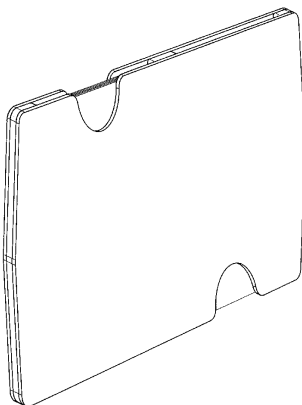

28.2

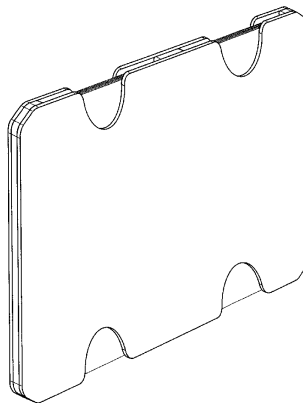

30.2

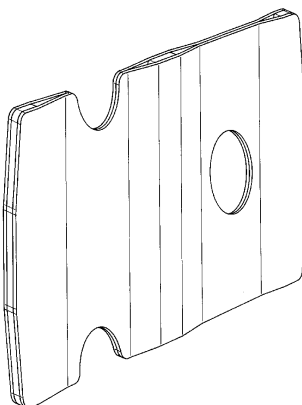

29.1

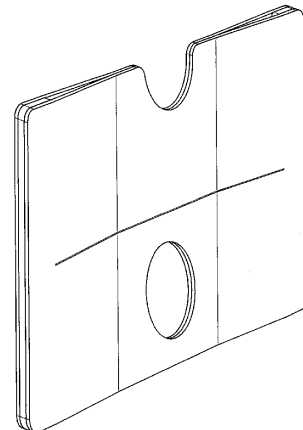

31.1

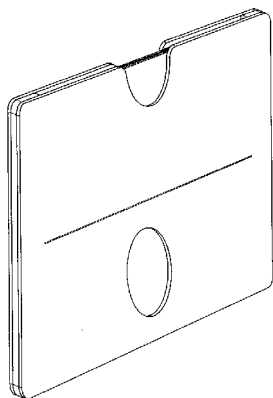

31.2

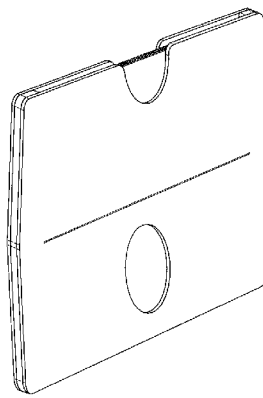

33.2

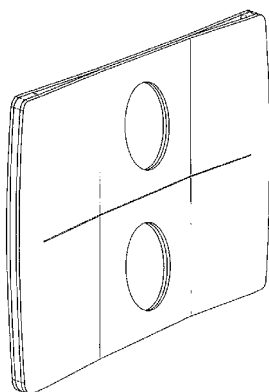

32.1

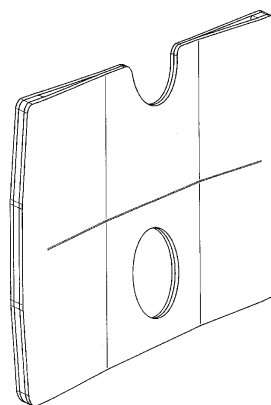

34.1

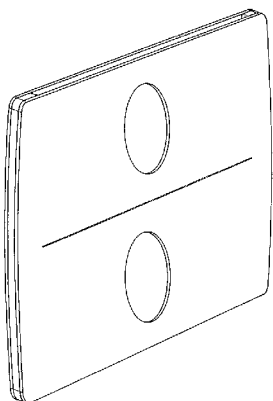

32.2

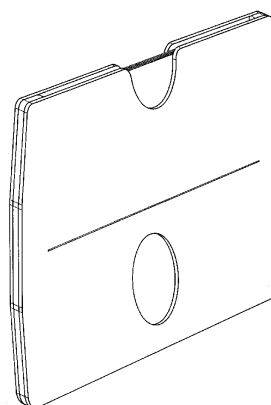

34.2

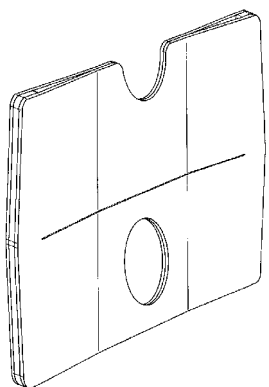

33.1

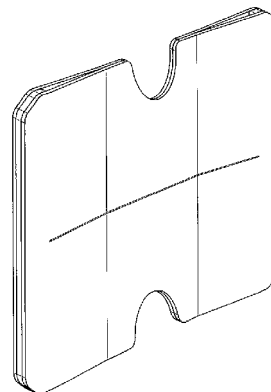

35.1

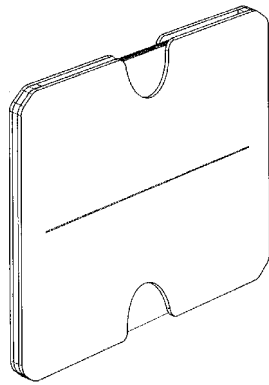

35.2

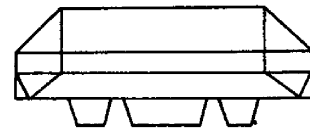

1.4

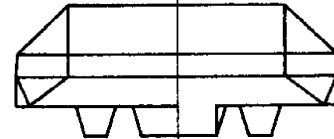

1.5



1.6

7 (51) 19/06.01

(11) 26717

(45) 7.10.2003

(73) Šulek Anton, Bratislava, SK;

(54) **Plastový písací prostriedok s integrovaným pántom a chráničom guľôčkovej náplne**

Určenie výrobku: Výrobok, v ktorom bude dizajn stelesnený alebo na ktorom bude aplikovaný, je plastový písací prostriedok s integrovaným pántom a chráničom guľôčkovej náplne učený na písanie.

(28) 25

Oznámenie o zápise dizajnu do registra vo Vestníku ÚPV SR č.: 10/2003

(55)

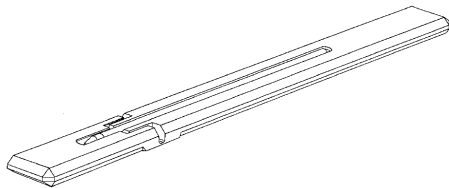

1.1

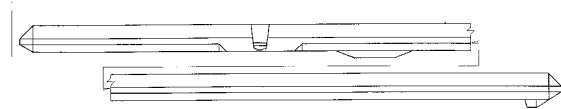

1.7

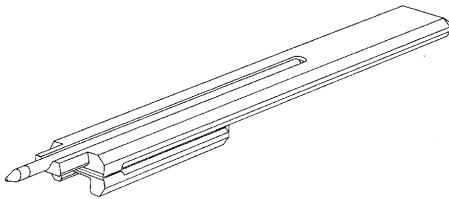

1.2

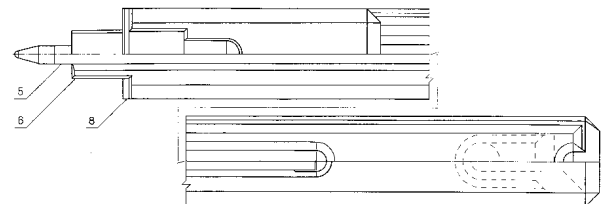

1.8

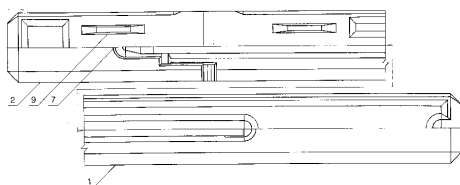

1.3

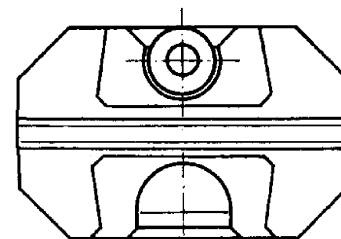

1.9



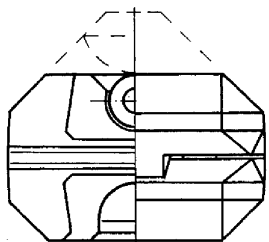

1.10

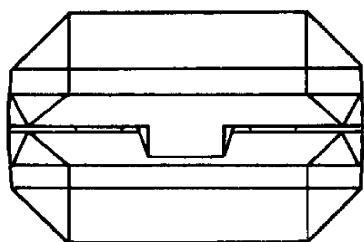

1.11

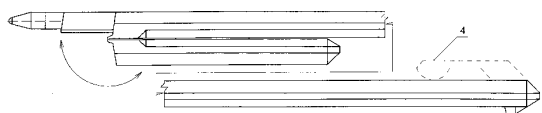

1.12

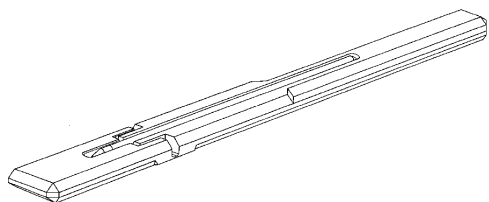

2.1

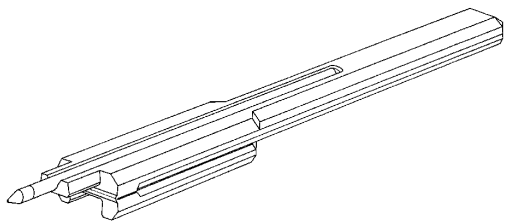

2.2

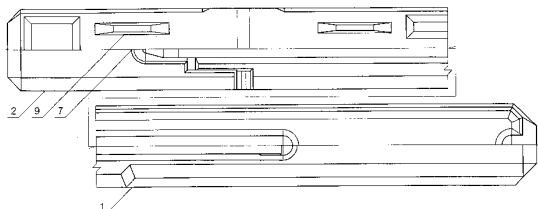

2.3

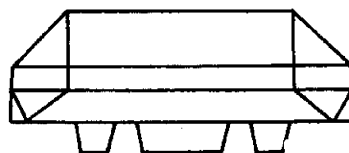

2.4

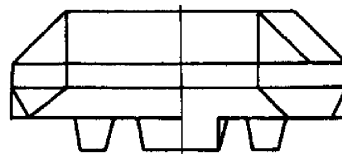

2.5

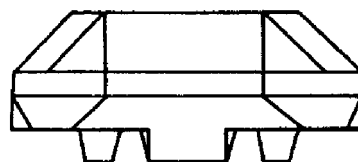

2.6

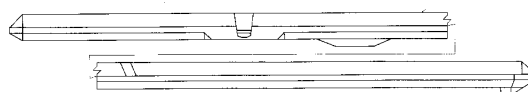

2.7

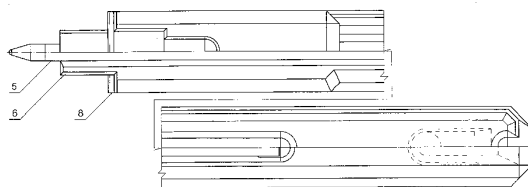

2.8

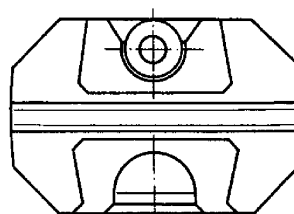

2.9

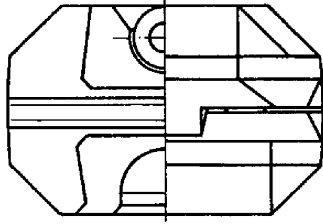

2.10

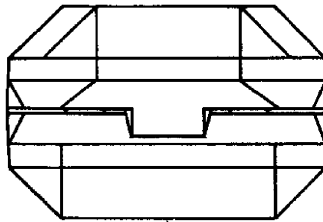

2.11

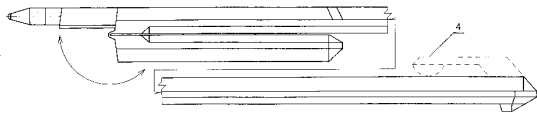

2.12

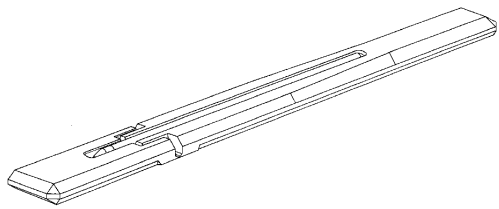

3.1

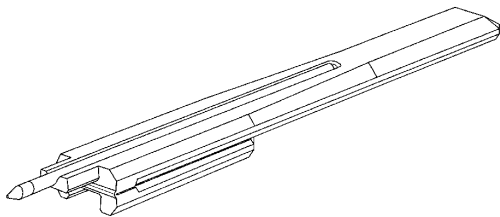

3.2

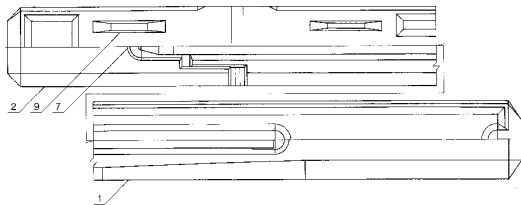

3.3

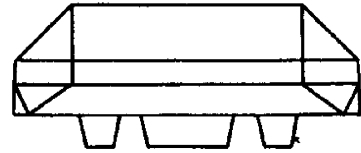

3.4



3.5

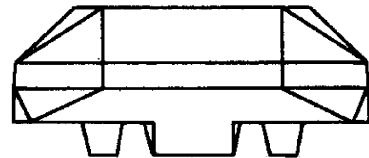

3.6



3.7

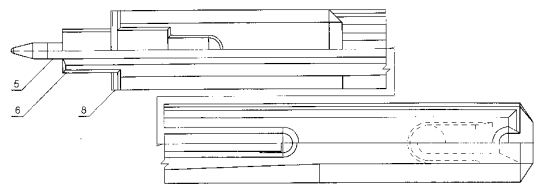

3.8

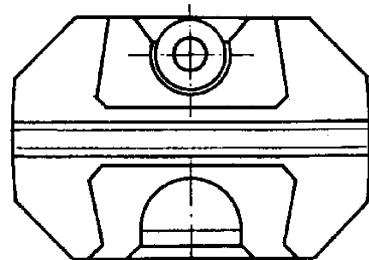

3.9

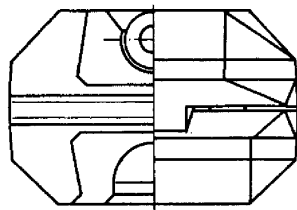

3.10

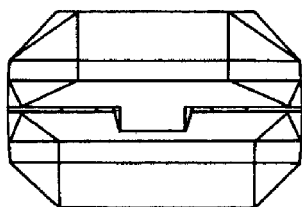

3.11

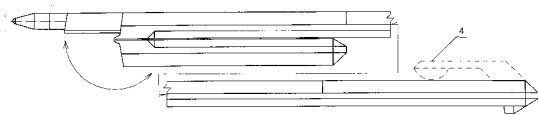

3.12

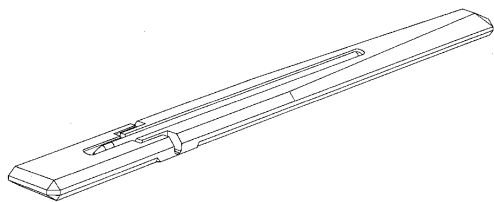

4.1

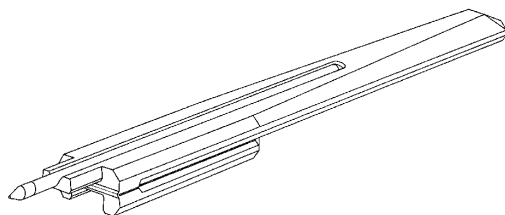

4.2

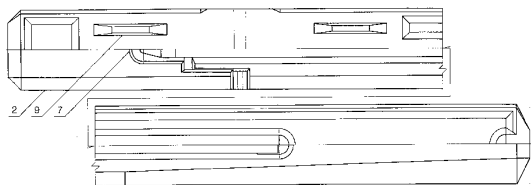

4.3



4.4

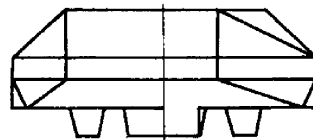

4.5

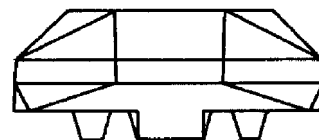

4.6

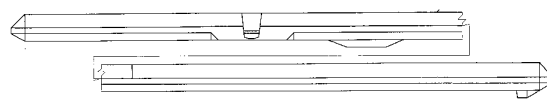

4.7

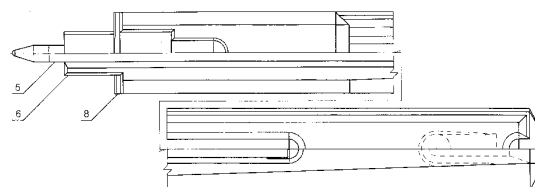

4.8

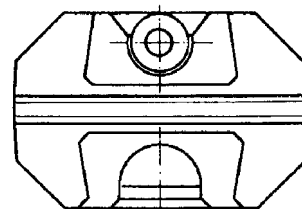

4.9

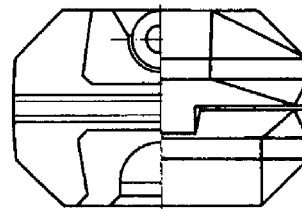

4.10

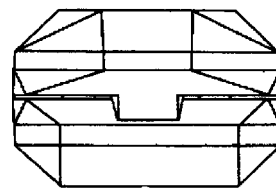

4.11

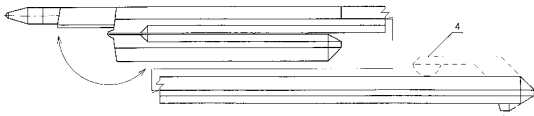

4.12

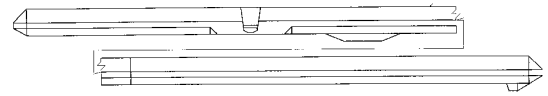

5.7

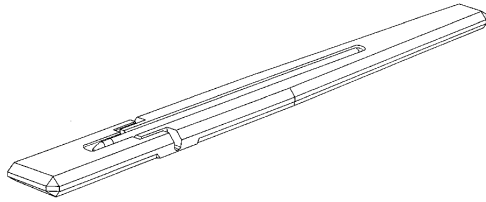

5.1

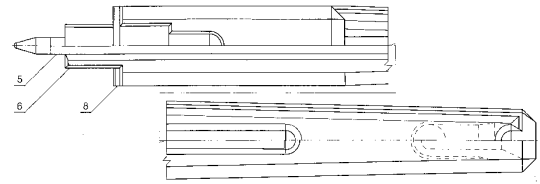

5.8

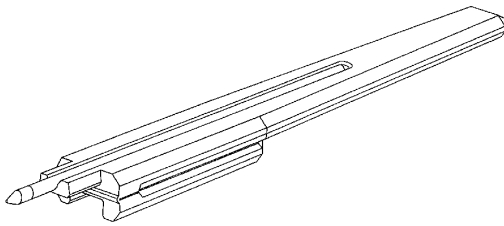

5.2

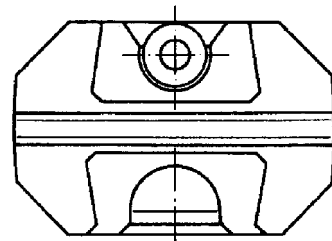

5.9

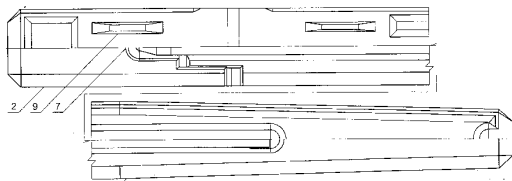

5.3

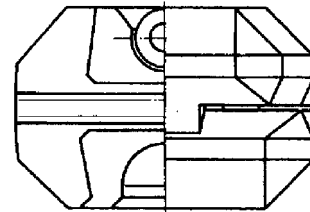

5.10



5.4

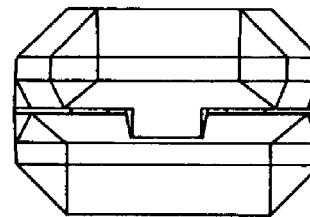

5.11

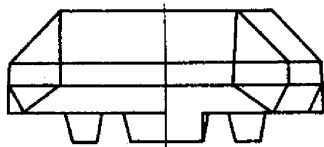

5.5

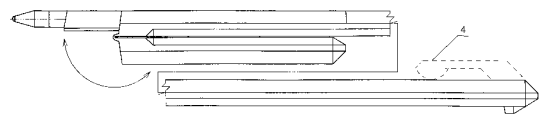

5.12

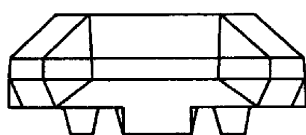

5.6

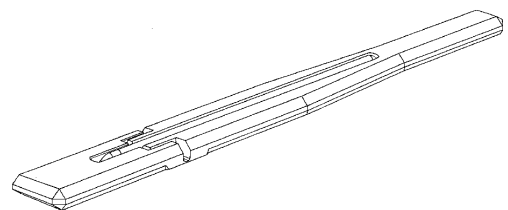

6.1

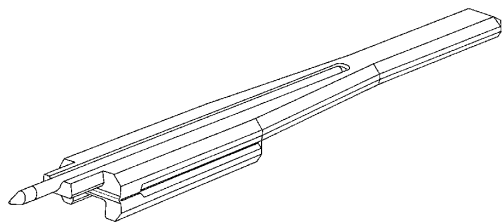

6.2

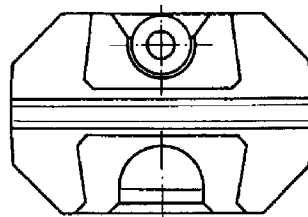

6.9

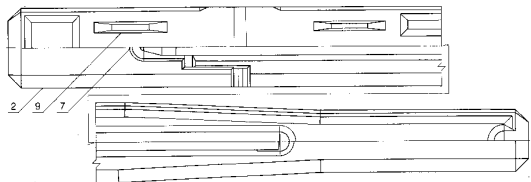

6.3

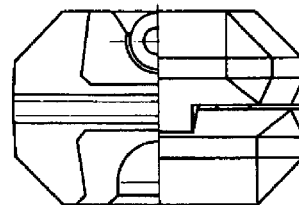

6.10



6.4

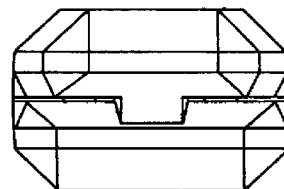

6.11



6.5

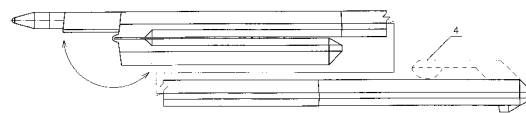

6.12

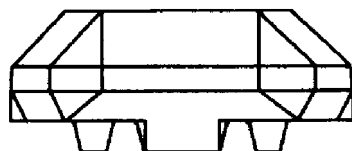

6.6

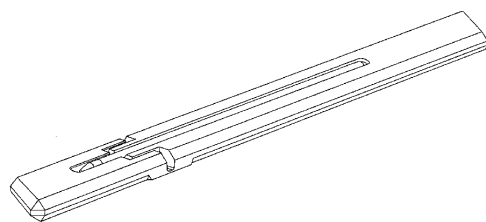

7.1

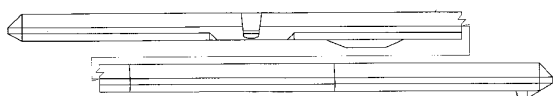

6.7

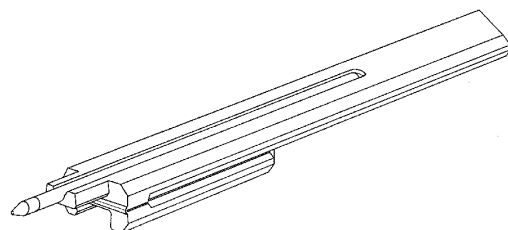

7.2

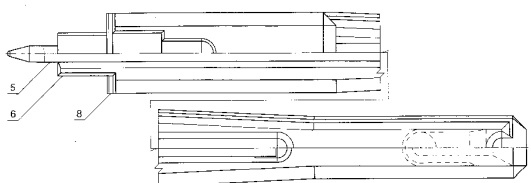

6.8

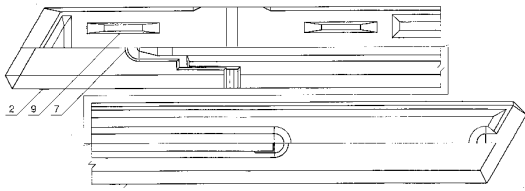

7.3

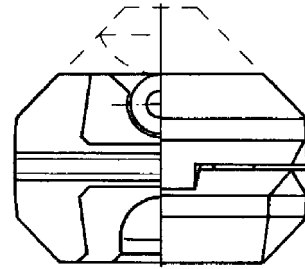

7.10

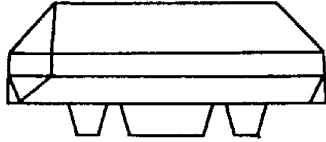

7.4

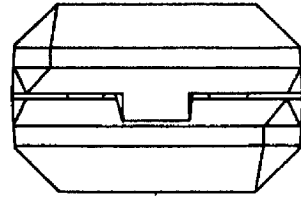

7.11



7.5

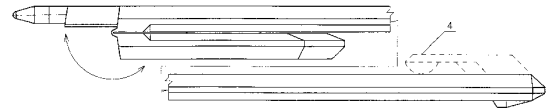

7.12

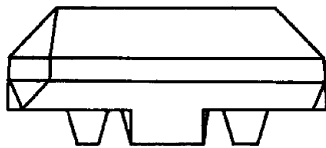

7.6

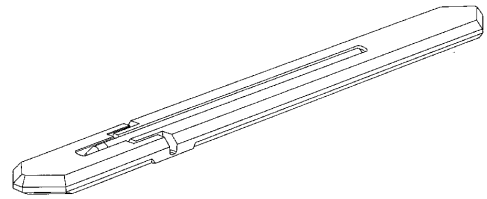

8.1

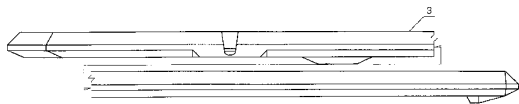

7.7

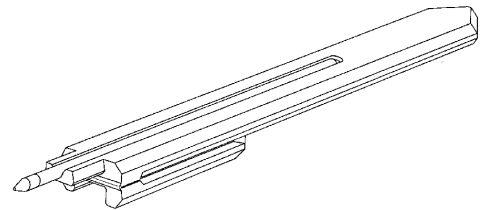

8.2

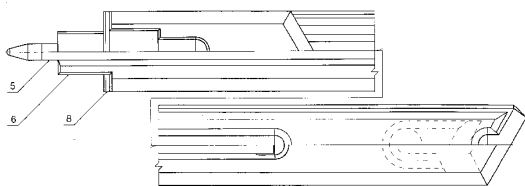

7.8

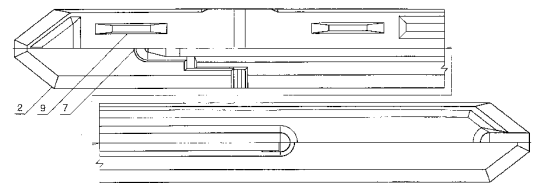

8.3

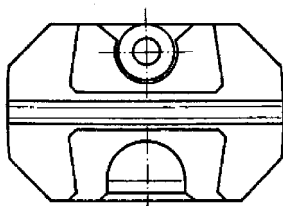

7.9

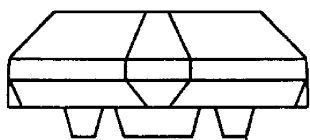

8.4

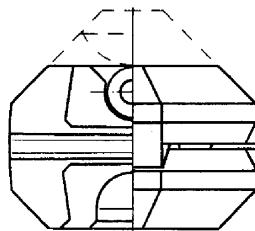

8.10

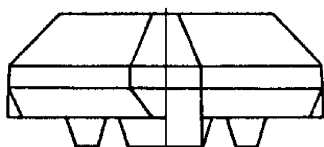

8.5

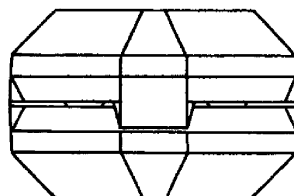

8.11

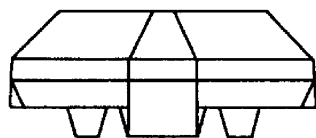

8.6

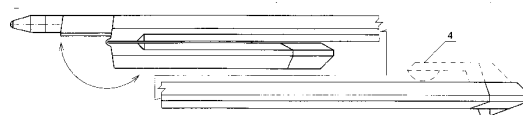

8.12

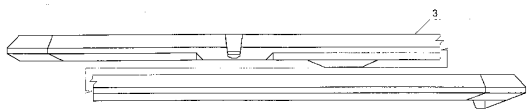

8.7

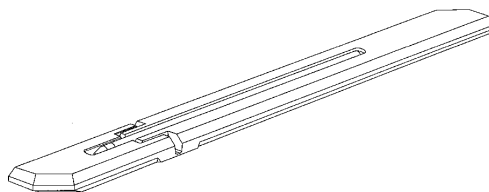

9.1

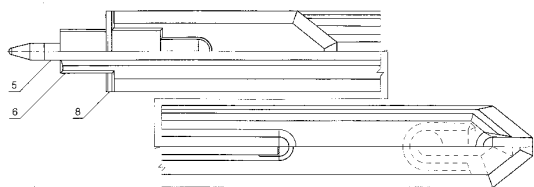

8.8

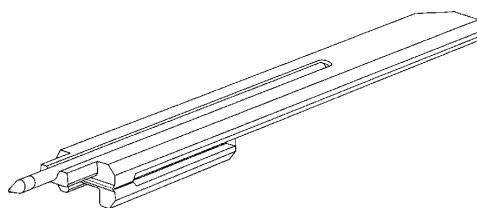

9.2

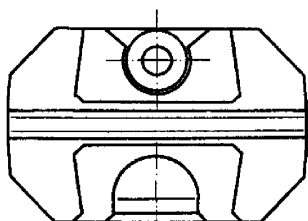

8.9

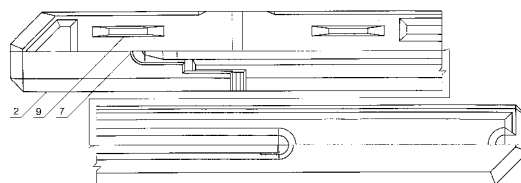

9.3



9.4

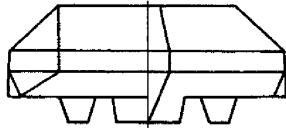

9.5

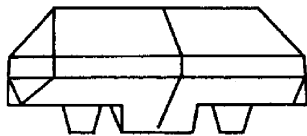

9.6

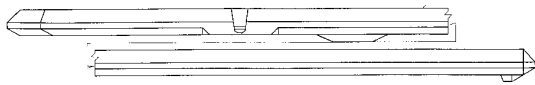

9.7

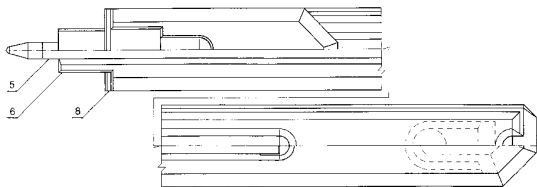

9.8

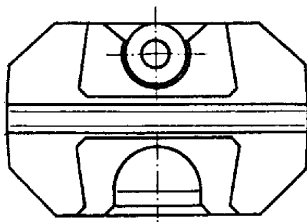

9.9

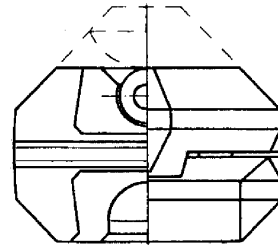

9.10

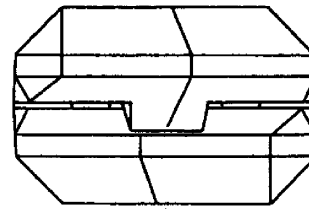

9.11

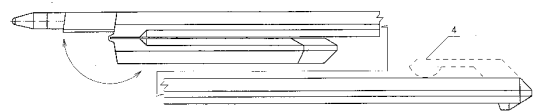

9.12

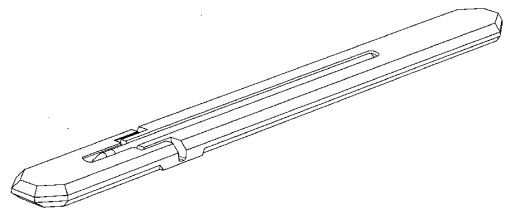

10.1

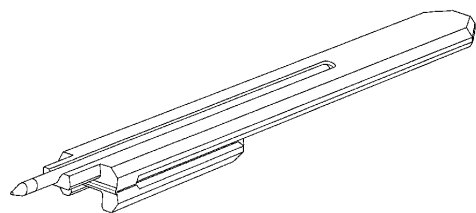

10.2

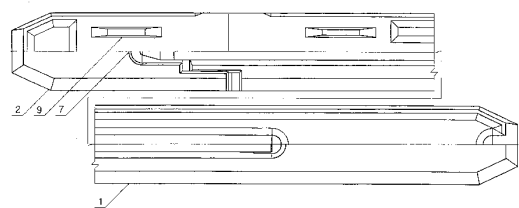

10.3





10.4

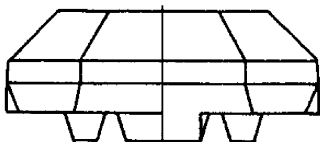

10.5

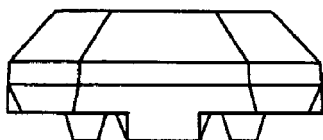

10.6



10.7

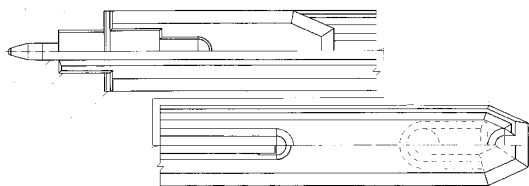

10.8

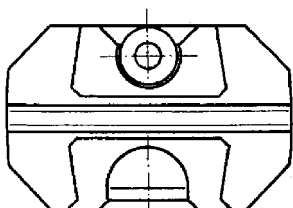

10.9

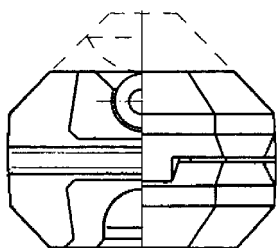

10.10

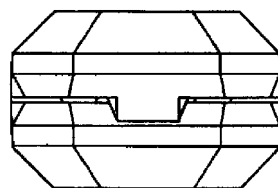

10.11



10.12

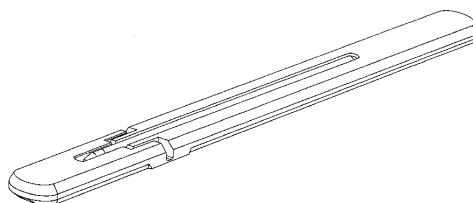

11.1

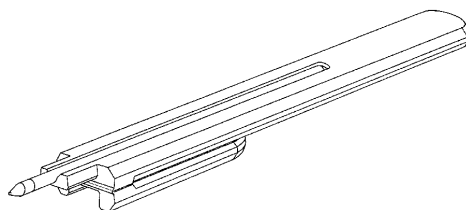

11.2

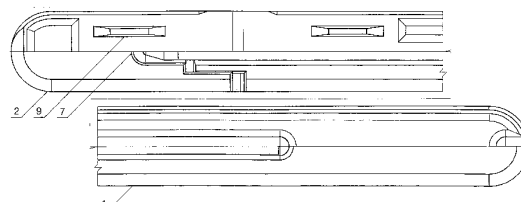

11.3



11.4

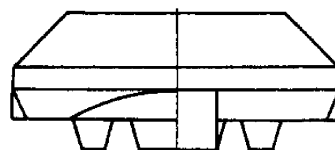

11.5

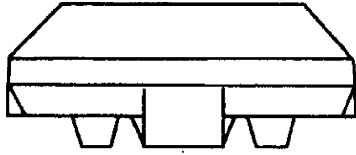

11.6

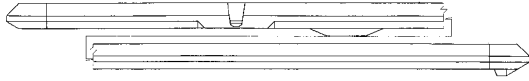

11.7

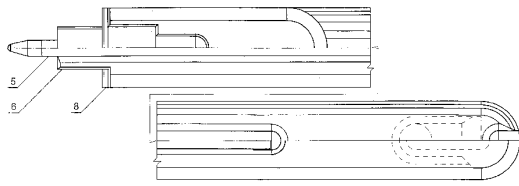

11.8

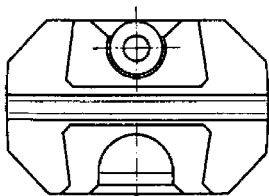

11.9

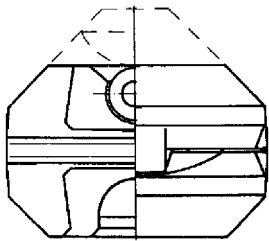

11.10

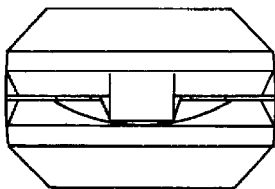

11.11

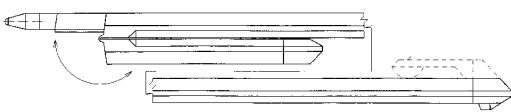

11.12

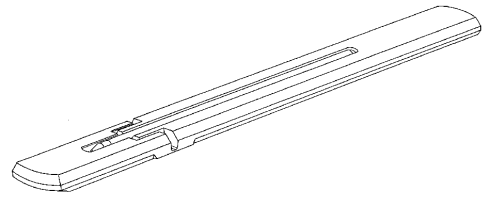

12.1

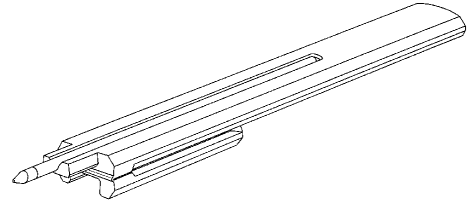

12.2

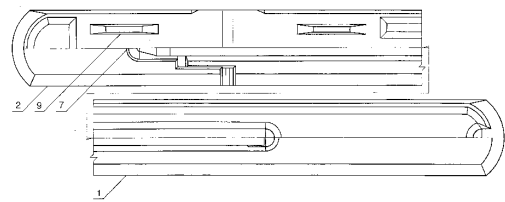

12.3



12.4

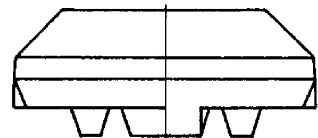

12.5



12.6

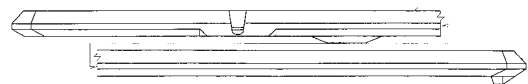

12.7

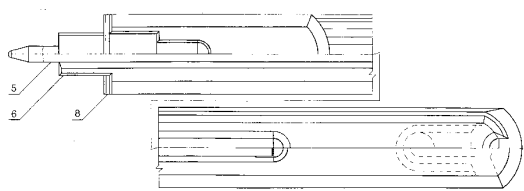

12.8

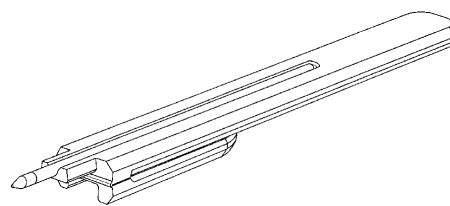

13.2

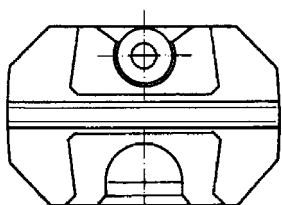

12.9

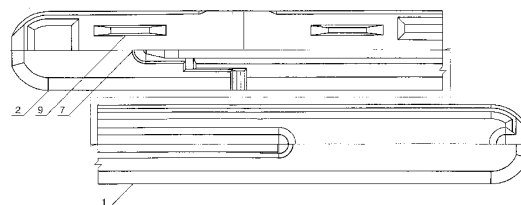

13.3

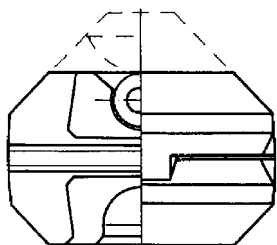

12.10

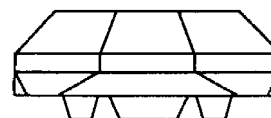

13.4

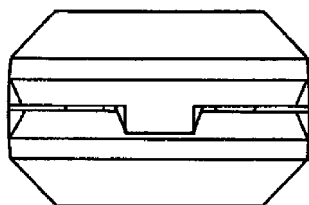

12.11

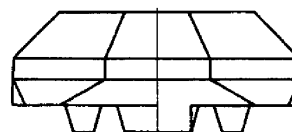

13.5

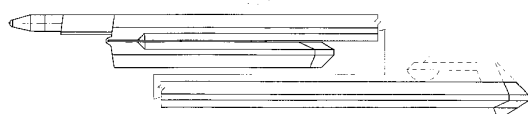

12.12

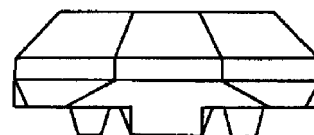

13.6

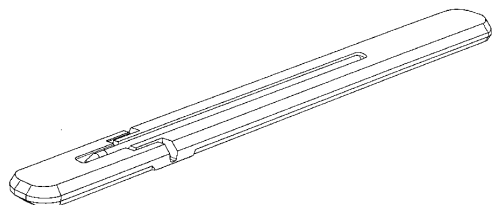

13.1

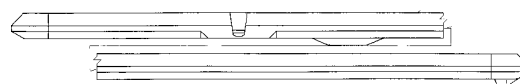

13.7

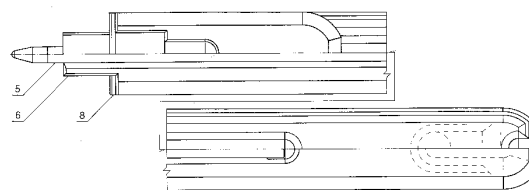

13.8

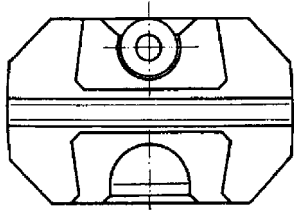

13.9

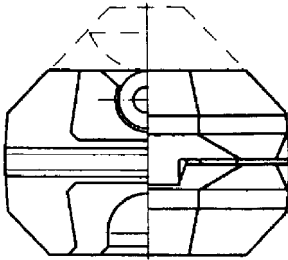

13.10

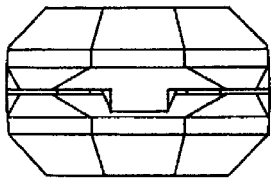

13.11

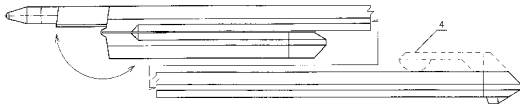

13.12

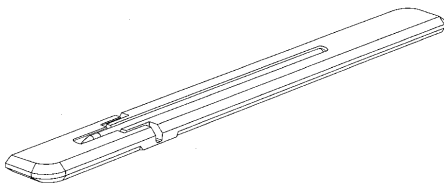

14.1

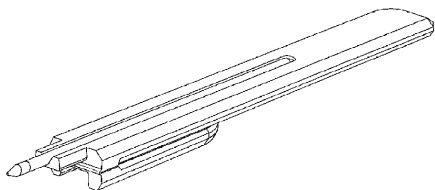

14.2

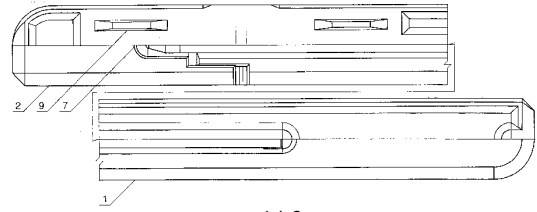

14.3

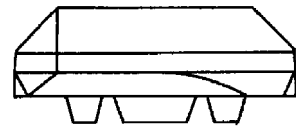

14.4

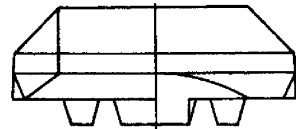

14.5

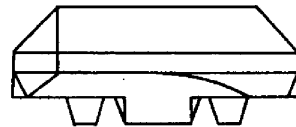

14.6

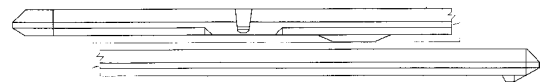

14.7

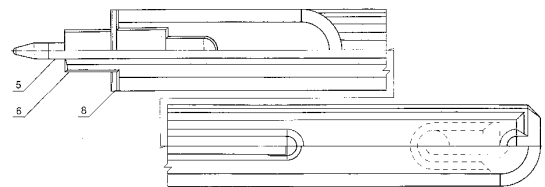

14.8

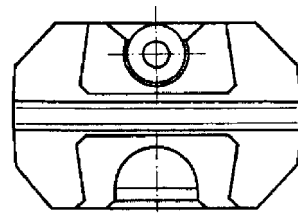

14.9

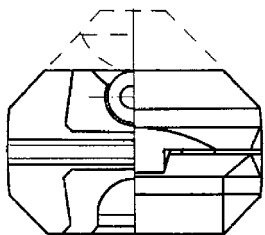

14.10

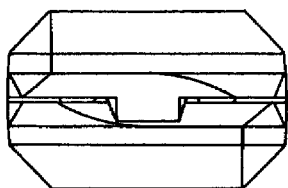

14.11

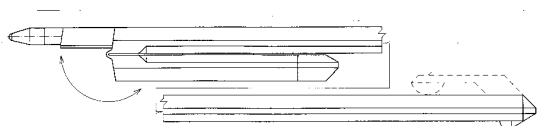

14.12

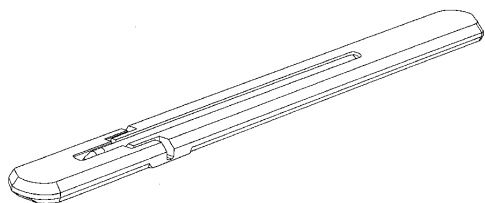

15.1

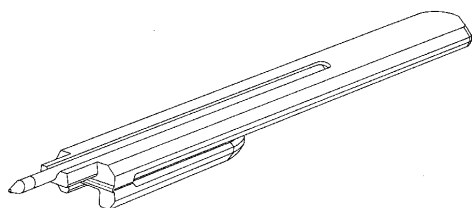

15.2

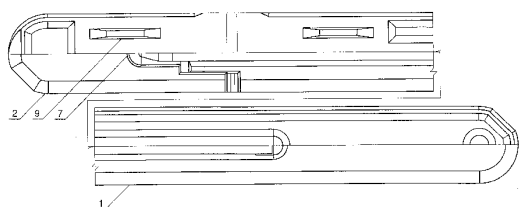

15.3

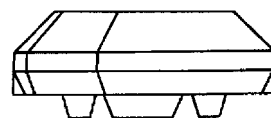

15.4

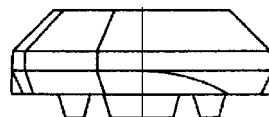

15.5



15.6

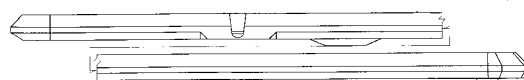

15.7

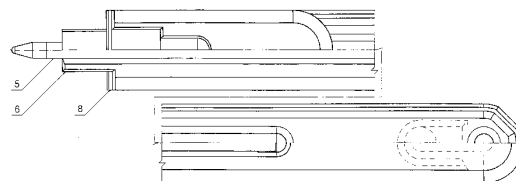

15.8

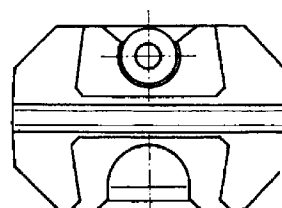

15.9

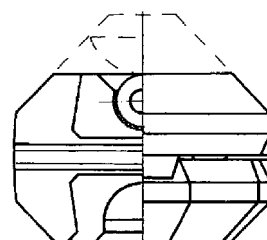

15.10

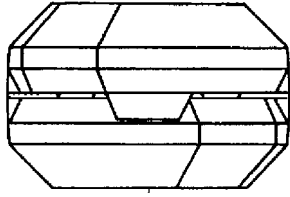

15.11

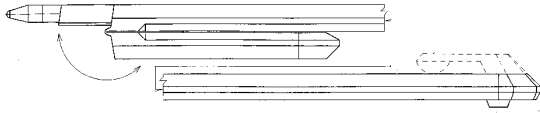

15.12

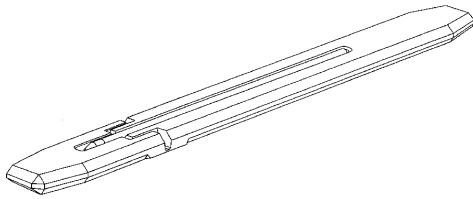

16.1

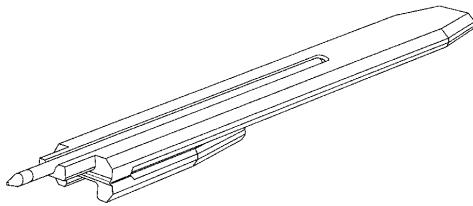

16.2

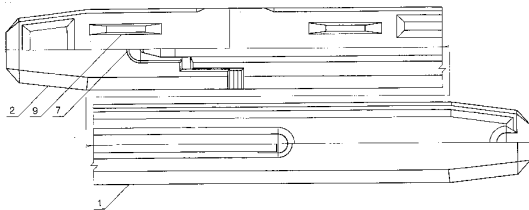

16.3

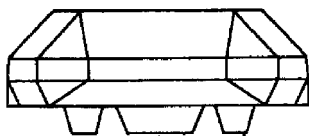

16.4

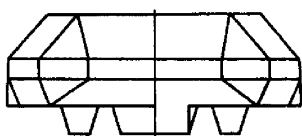

16.5

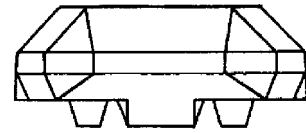

16.6

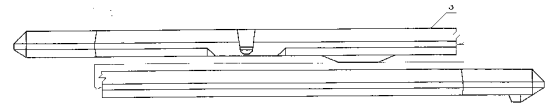

16.7

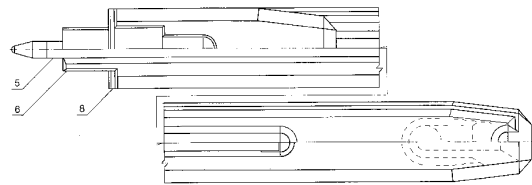

16.8

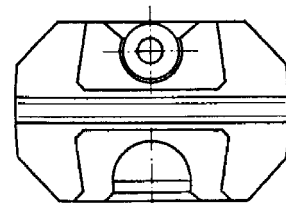

16.9

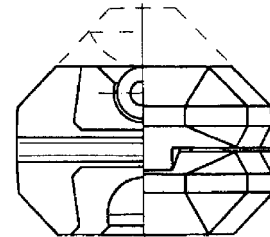

16.10

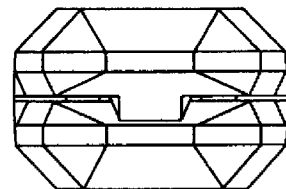

16.11

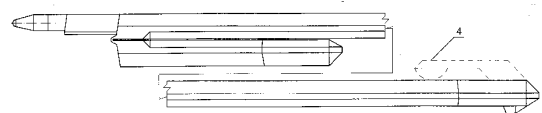

16.12

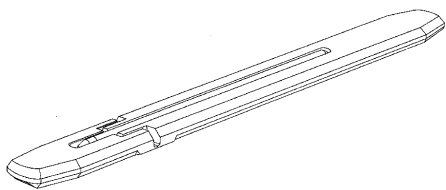

17.1

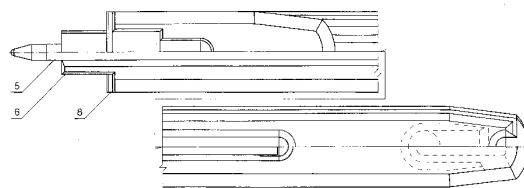

17.8

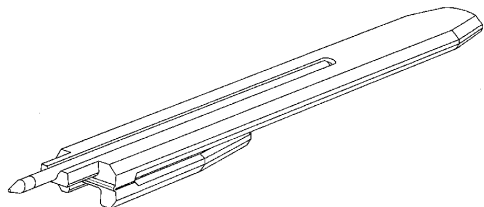

17.2

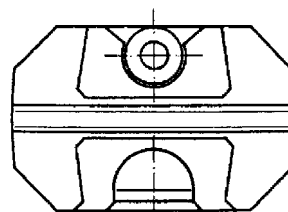

17.9

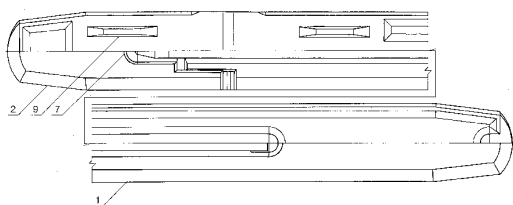

17.3

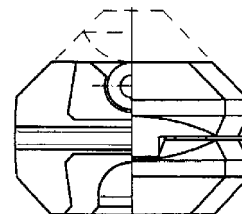

17.10



17.4

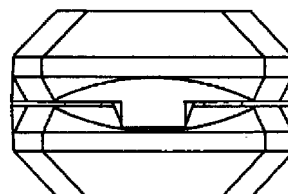

17.11

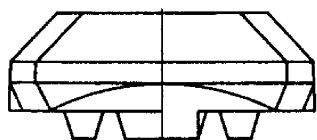

17.5

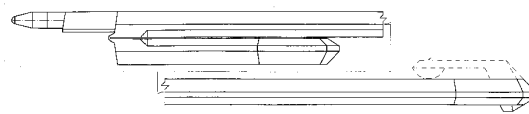

17.12

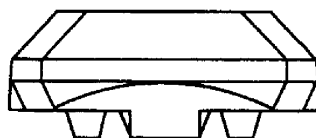

17.6

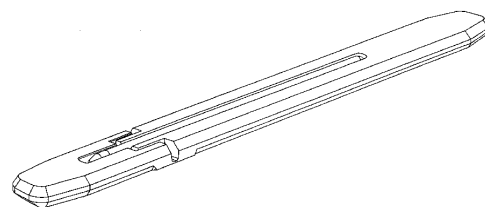

18.1

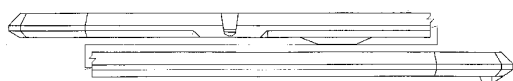

17.7

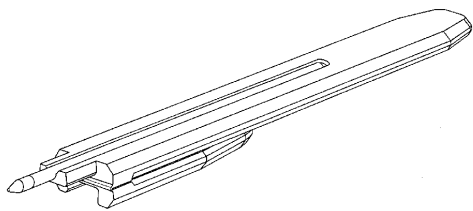

18.2

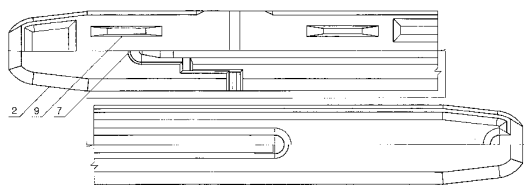

18.3

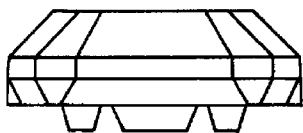

18.4

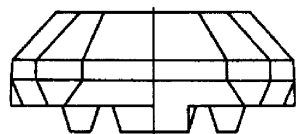

18.5

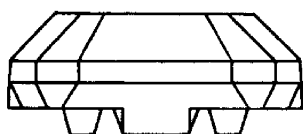

18.6

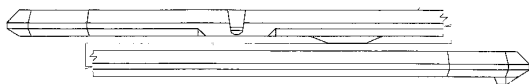

18.7

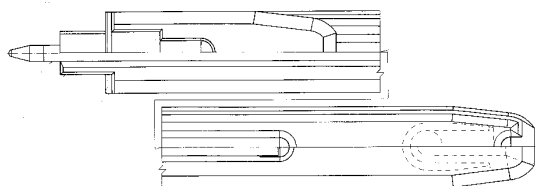

18.8

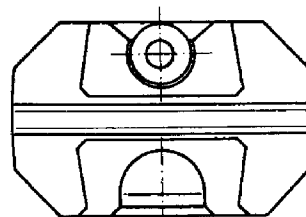

18.9

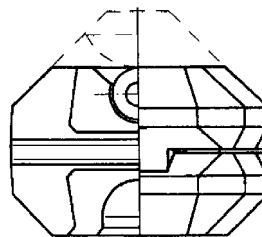

18.10

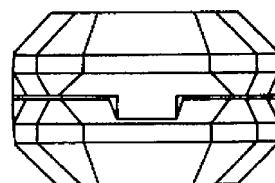

18.11

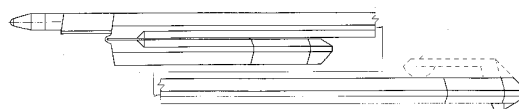

18.12

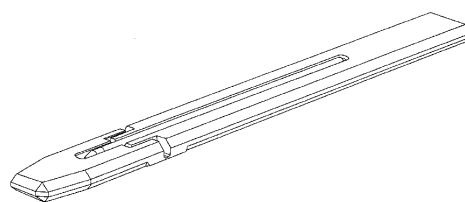

19.1

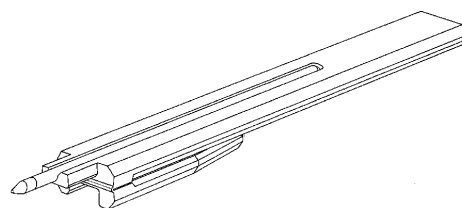

19.2



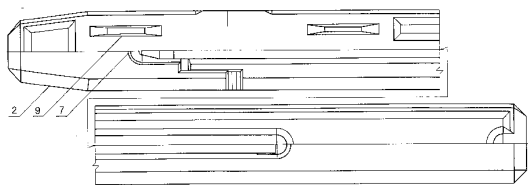

19.3

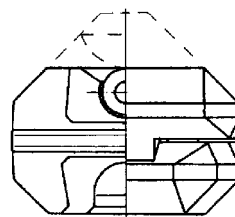

19.10

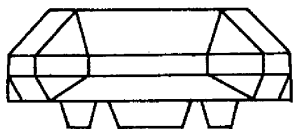

19.4

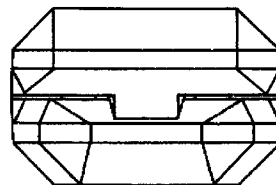

19.11

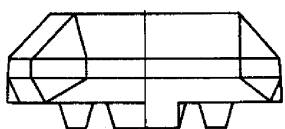

19.5

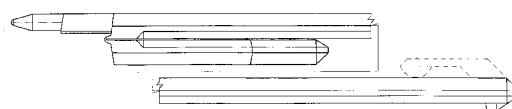

19.12



19.6

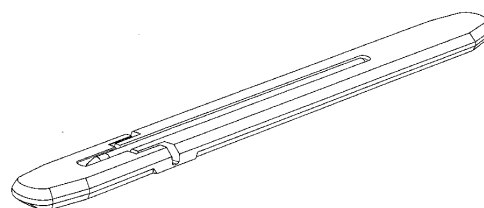

20.1

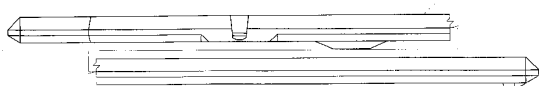

19.7

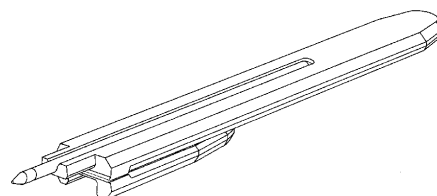

20.2

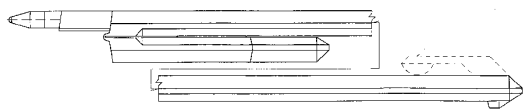

19.8

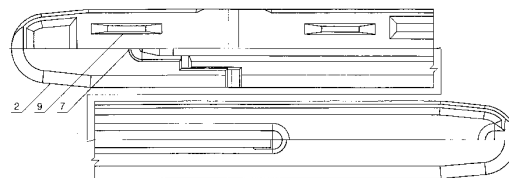

20.3

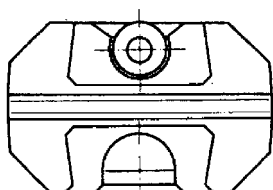

19.9

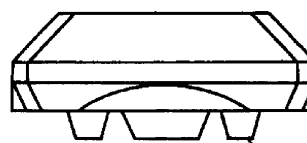

20.4

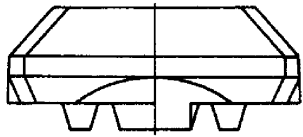

20.5

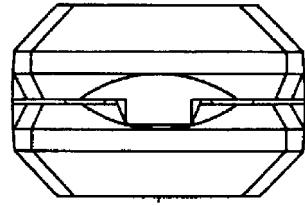

20.11

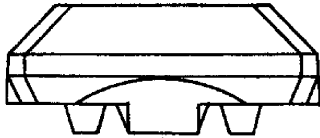

20.6

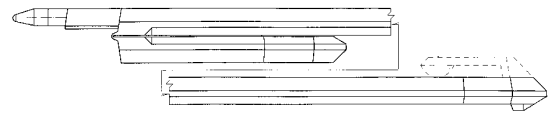

20.12

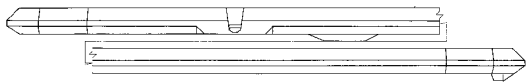

20.7

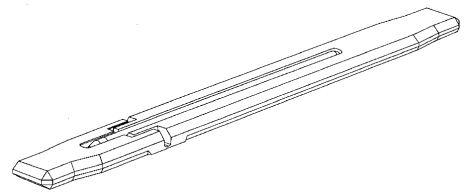

21.1

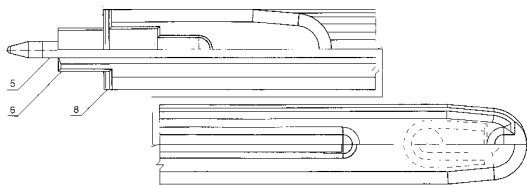

20.8

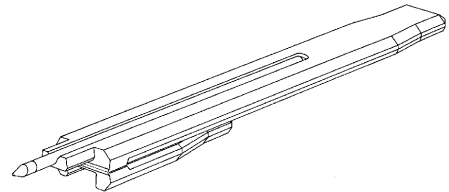

21.2

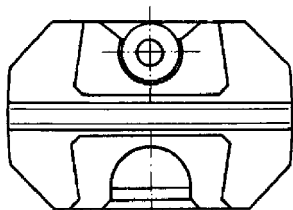

20.9

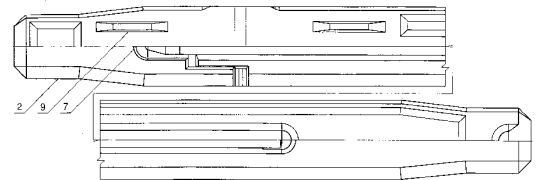

21.3

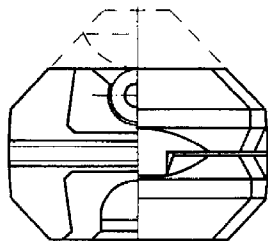

20.10

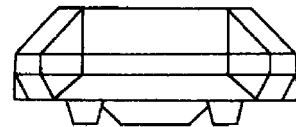

21.4

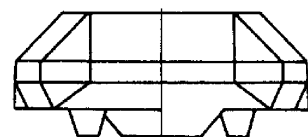

21.5

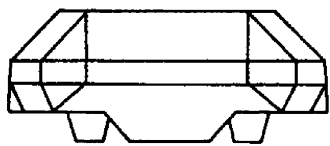

21.6

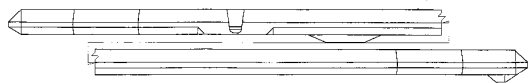

21.7

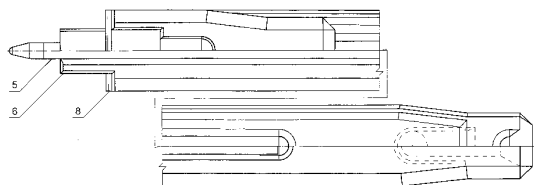

21.8

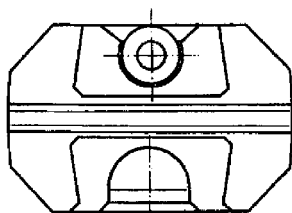

21.9

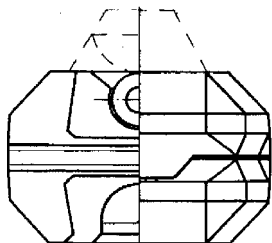

21.10

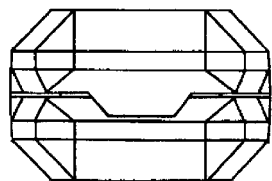

21.11

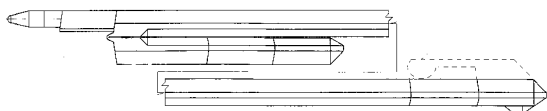

21.12

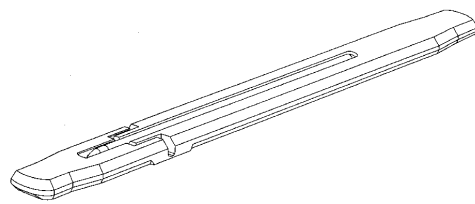

22.1

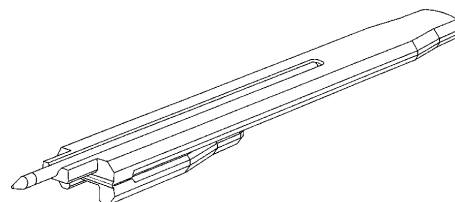

22.2

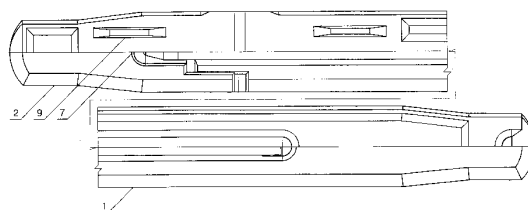

22.3



22.4

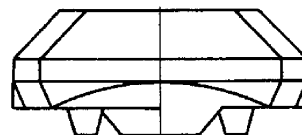

22.5



22.6

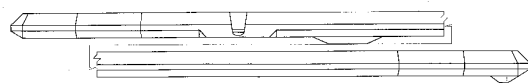

22.7

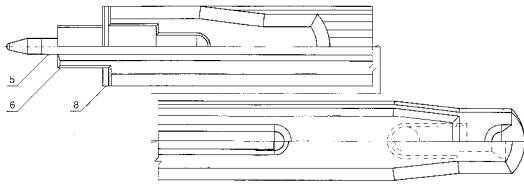

22.8

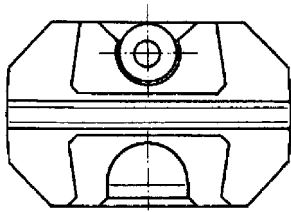

22.9

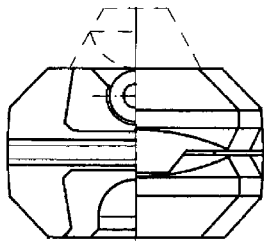

22.10

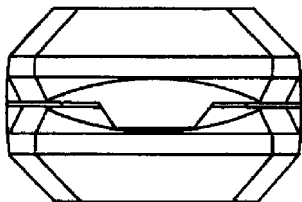

22.11

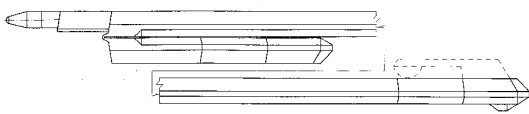

22.12

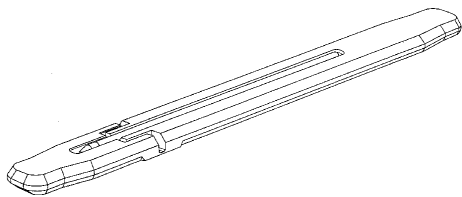

23.1

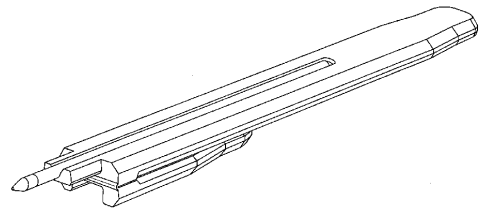

23.2

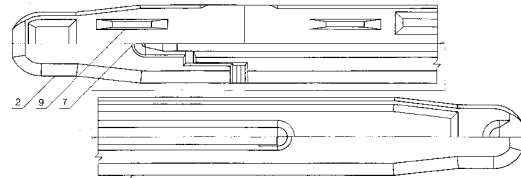

23.3

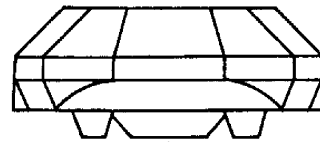

23.4

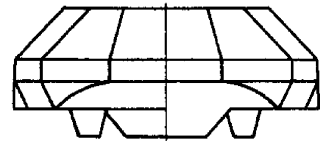

23.5

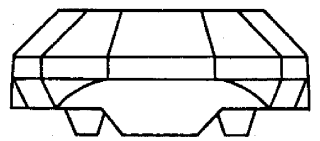

23.6

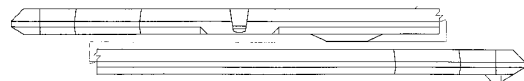

23.7

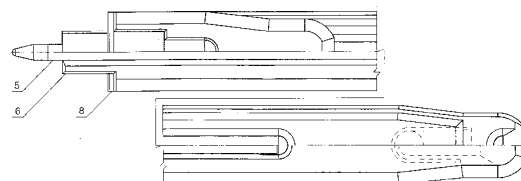

23.8

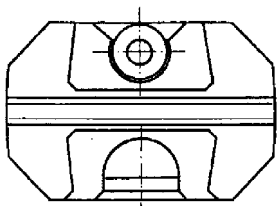

23.9

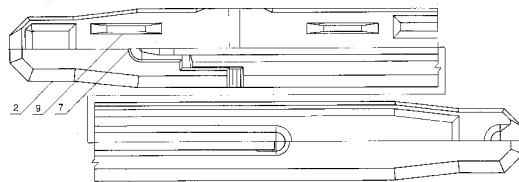

24.3

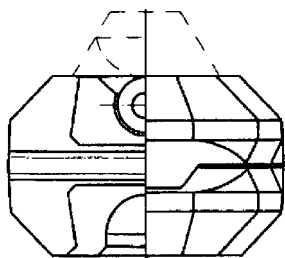

23.10



24.4

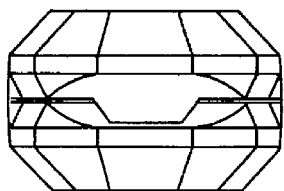

23.11

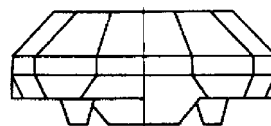

24.5

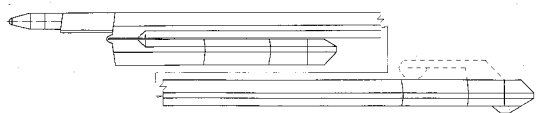

23.12

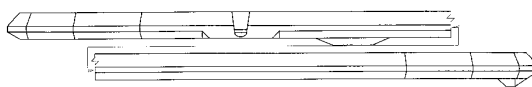

24.6

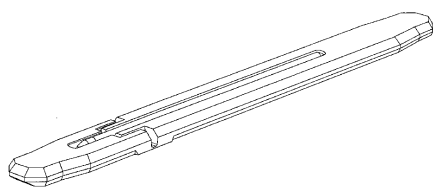

24.1

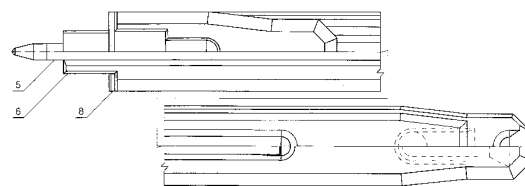

24.7

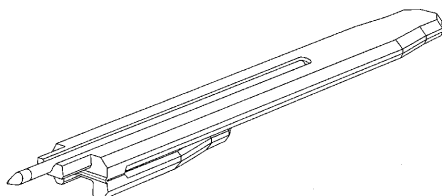

24.2

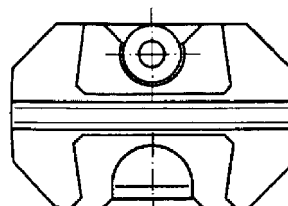

24.8

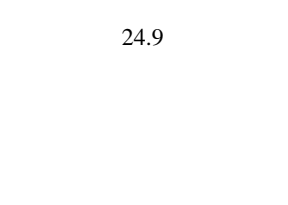

24.9

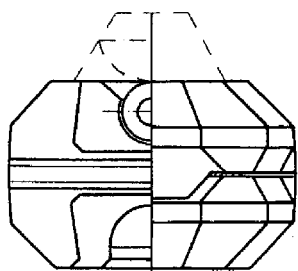

24.10

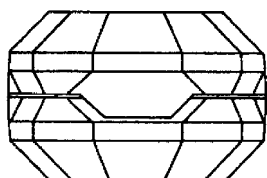

24.11

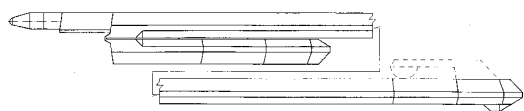

24.12

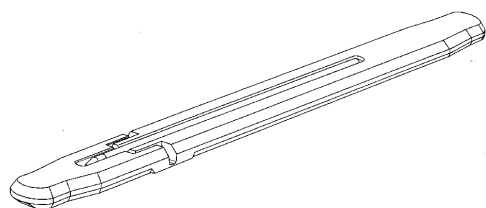

25.1

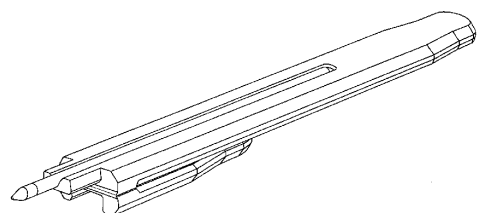

25.2

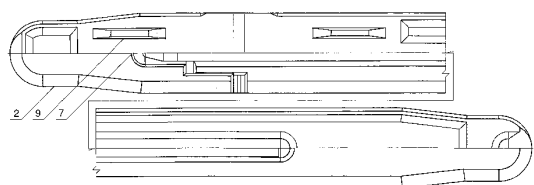

25.3



25.4

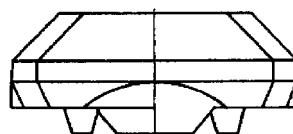

25.5



25.6



25.7

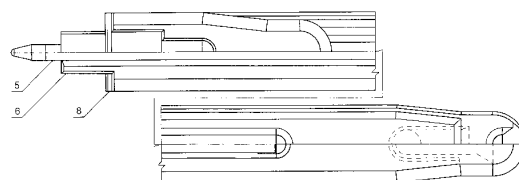

25.8

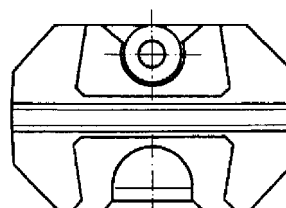

25.9

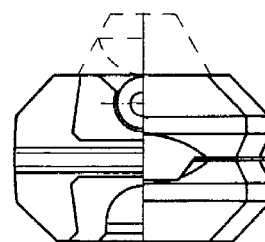

25.10

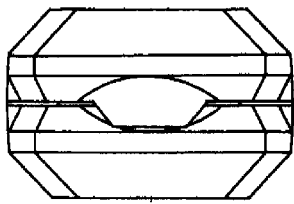

25.11

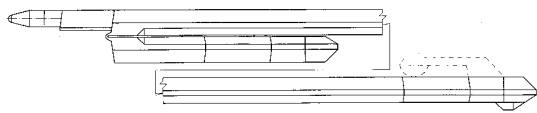

25.12

---

(51)

(11)

03/01.12

26742

19/06.01

26717

**MK4Q Zaniknuté zapísané dizajny uplynutím doby platnosti**

(11)	Dátum zániku	(11)	Dátum zániku	(11)	Dátum zániku	(11)	Dátum zániku
24616	13.10.2004	25972	01.10.2004	25993	06.10.2004	26132	12.10.2004
24660	18.10.2004	25978	21.10.2004	26000	01.10.2004	26189	20.10.2004
24685	12.10.2004	25979	21.10.2004	26021	06.10.2004	26214	06.10.2004
24810	17.10.2004	25980	21.10.2004	26024	08.10.2004	26236	06.10.2004
24867	18.10.2004	25981	21.10.2004	26085	18.10.2004		
25958	21.10.2004	25982	21.10.2004	26120	08.10.2004		
25959	21.10.2004	25983	27.10.2004	26131	08.10.2004		

**ND4Q Predĺženie platnosti zapísaných dizajnov**

(11)	(51)	(11)	(51)	(11)	(51)	(11)	(51)
24898	23/03.02	24951	10/02.02	25003	23/03.02	26286	11/02.01

**7 (51) 10/02.02**  
**(11) 24951**  
 (15) 25.11.1996  
 (18) 10.7.2010  
 (21) 213-95  
 (22) 10.7.1995  
 (73) TAG Heuer S. A., Marin, CH;  
**(54) Náramkové hodinky 2000**

**7 (51) 23/03.02**  
**(11) 25003**  
 (15) 19.12.1996  
 (18) 25.7.2010  
 (21) 225-95  
 (22) 25.7.1995  
 (73) RUNTAL HOLDING COMPANY S.A., CH-5722 Gränichen, CH;  
**(54) Radiátor**

**7 (51) 11/02.01**  
**(11) 26286**  
 (15) 14.6.2001  
 (18) 4.5.2010  
 (21) 92-2000  
 (22) 4.5.2000  
 (73) Ragan Jozef, Vranov nad Topľou, SK;  
**(54) Sklo s grafickým vzorom na povrchu**

**7 (51) 23/03.02**  
**(11) 24898**  
 (15) 11.9.1996  
 (18) 9.6.2010  
 (21) 165-95  
 (22) 9.6.1995  
 (73) RUNTAL HOLDING COMPANY S.A., CH-5722 Gränichen, CH;  
**(54) Radiátor**

(51)	(11)	(51)	(11)	(51)	(11)	(51)	(11)
10/02.02	24951	11/02.01	26286	23/03.02	25003	23/03.02	24898