

**ČASŤ**

**DIZAJNY**

## Číselné INID - kódy na označovanie bibliografických údajov (Štandard WIPO ST. 80)

(11)	Číslo zapísaného dizajnu	(51)	Medzinárodné triedenie dizajnov
(15)	Dátum zápisu/predĺženia platnosti	(54)	Názov dizajnu
(18)	Predpokladaný dátum uplynutia platnosti zápisu/predĺženia platnosti	(55)	Vyobrazenie dizajnu/vyobrazenie dizajnu po čiastočnom výmaze
(21)	Číslo prihlášky	(58)	Dátum záznamu v registri, napr. zmeny mena, zániku, výmazu a pod.
(22)	Dátum podania prihlášky	(62)	Číslo pôvodnej prihlášky v prípade vylúčenej prihlášky
(24)	Dátum nadobudnutia účinkov zapísaného dizajnu	(71)	Meno (názov) a adresa prihlasovateľa (-ov)
(28)	Počet dizajnov	(72)	Meno pôvodcu (-ov)
(31)	Číslo prioritnej prihlášky	(73)	Meno (názov) a adresa majiteľa (-ov)
(32)	Dátum podania prioritnej prihlášky	(74)	Meno (názov) a adresa zástupcu (-ov)
(33)	Krajina alebo regionálna organizácia priority	(78)	Meno (názov) a adresa nového majiteľa (-ov) po prevode alebo prechode
(45)	Dátum sprístupnenia zapísaného dizajnu		
(46)	Dátum uplynutia odkladu zverejnenia		

Poznámka:

Číslo uvádzané pred kódom (51) znamená verziu Medzinárodného triedenia dizajnov

## Kódy na označovanie záhlaví oznámení publikovaných vo Vestníku ÚPV SR (Štandard WIPO ST. 17)

<b>FG4Q</b>	Zapísané dizajny
<b>MA4Q</b>	Zaniknuté zapísané dizajny vzdaním sa
<b>MC4Q</b>	Vymazané zapísané dizajny
<b>MG4Q</b>	Čiastočne vymazané zapísané dizajny
<b>MK4Q</b>	Zaniknuté zapísané dizajny uplynutím doby platnosti
<b>MM4Q</b>	Zaniknuté zapísané dizajny pre nezaplatenie poplatkov za predĺženie platnosti
<b>ND4Q</b>	Predĺženie platnosti zapísaných dizajnov
<b>PC4Q</b>	Prevody a prechody práv
<b>PD4Q</b>	Zmeny dispozičných práv na zapísané dizajny (zálohy)
<b>PD4Q</b>	Zmeny dispozičných práv na zapísané dizajny (ukončenie záloh)
<b>QB4Q</b>	Registrované licenčné zmluvy
<b>QC4Q</b>	Ukončenie platnosti licenčných zmlúv
<b>TA4Q</b>	Doplnenie mena pôvodcu (-ov)
<b>TB4Q</b>	Opravy mien
<b>TC4Q</b>	Zmeny mien
<b>TD4Q</b>	Opravy adries
<b>TE4Q</b>	Zmeny adries
<b>TF4Q</b>	Opravy dátumov
<b>TG4Q</b>	Opravy medzinárodného triedenia
<b>TH4Q</b>	Opravy chýb alebo zmeny všeobecne
<b>TK4Q</b>	Opravy tlačových chýb vo Vestníku ÚPV SR

## FG4Q

## Zapísané dizajny

(11)	(51)	(11)	(51)	(11)	(51)	(11)	(51)
26592	06/05.07	26596	13/03.03	26600	28/01.00	26604	11/02.05
26593	24/04.06	26597	23/03.01	26601	02/04.06	26605	19/01.00
26594	30/99.00	26598	14/02.03	26602	23/04.06		
26595	26/04.04	26599	31/00.00	26603	06/04.08		

## 7 (51) 02/04.06

## (11) 26601

(15) 06.02.2003

(18) 30.07.2007

(21) 156-2002

(22) 30.07.2002

(24) 06.02.2003

(45) 01.04.2003

(72) Matys Miroslav, Ing., OBUV - ŠPECIÁL, spol. s r. o., Bardejov, SK;

(73) OBUV - ŠPECIÁL, spol. s r. o., Bardejov, SK;

(54) Pilotná obuv - vzor 2001.1

(28) 1

(55)



1.1



1.2



1.3

## 7 (51) 06/04.08

## (11) 26603

(15) 18.02.2003

(18) 13.05.2007

(21) 102-2002

(22) 13.05.2002

(24) 18.02.2003

(45) 01.04.2003

(72) Šuch Dušan, Ing., Košice, SK;

(73) KATEDRA DIZAJNU, Košice, SK;

(54) Priemyselná kuchynská linka

(28) 1

(55)

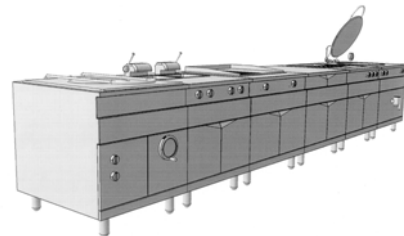

1.1

## 7 (51) 06/05.07

## (11) 26592

(15) 06.02.2003

(18) 14.03.2007

(21) 67-2002

(22) 14.03.2002

(24) 06.02.2003

(45) 01.04.2003

(72) Nemeš Pavol, Šurany, SK;

(73) Nemeš Pavol, Šurany, SK;

(54) Nábytok do detskej izby predstavujúci vlakovú súpravu

(28) 1

(55)

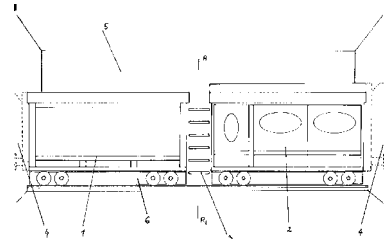

1.1

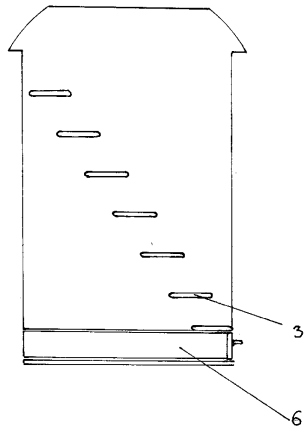

1.2



2.1

7 (51) 11/02.05

(11) 26604

(15) 18.02.2003

(18) 14.05.2007

(21) 105-2002

(22) 14.05.2002

(24) 18.02.2003

(45) 01.04.2003

(72) Pekar Marcel, Mgr., Považská Bystirca, SK;

(73) Pekar Marcel, Mgr., Považská Bystirca, SK;

(74) Zahatňanská Gabriela, Ing., Žilina, SK;

(54) **Dáma a jej rytieri**

(28) 15

(55)

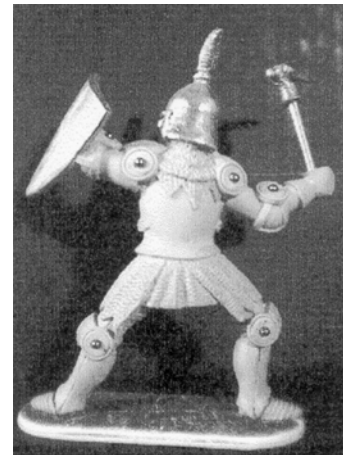

2.2



1.1



3.1



1.2



3.2



4.3



4.1



5.1



4.2



5.2



5.3



7.1



6.1



7.2

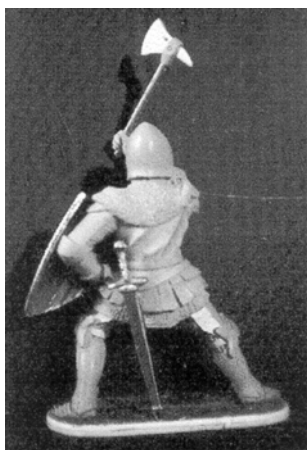

6.2



8.1



6.3



8.2



9.1



9.2



10.1

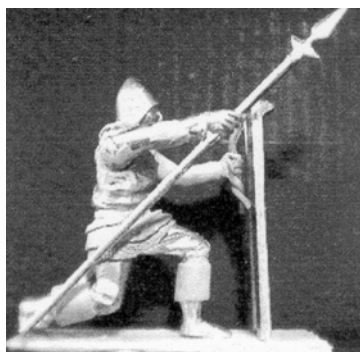

10.2



10.3



11.1



11.2



11.3



12.1



14.1

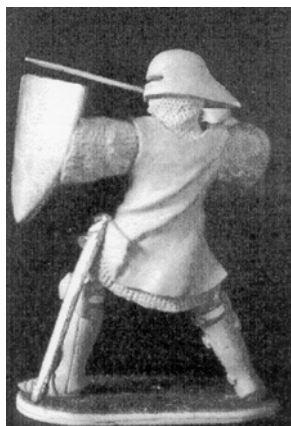

12.2



14.2



13.1



15.1

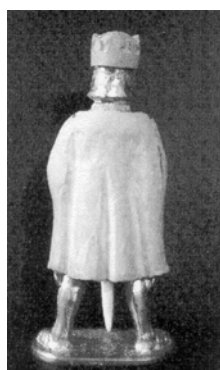

13.2



15.2





15.3

(55)



1.1

**7 (51) 13/03.03****(11) 26596**

(15) 06.02.2003

(18) 20.05.2007

(21) 112-2002

(22) 20.05.2002

(24) 06.02.2003

(45) 01.04.2003

(72) Kunce Jan, Jablonec nad Nisou, CZ;

(73) ABB Elektro Praga, s. r. o., Jablonec nad Nisou, CZ;

(74) Hojčuš Peter, Ing., Bratislava, SK;

**(54) Zásuvka**

(28) 1

(55)

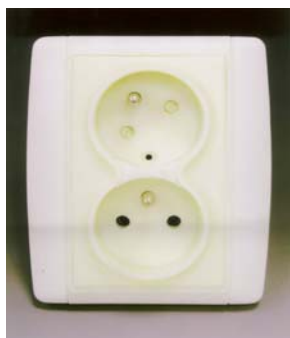

1.1

**7 (51) 19/01.00****(11) 26605**

(15) 18.02.2003

(18) 24.07.2007

(21) 151-2002

(22) 24.07.2002

(24) 18.02.2003

(45) 01.04.2003

(72) Kečka Stanislav, Ing., Poprad, SK; Janoščík Ján, Poprad, SK; Janoščíková Beáta, Poprad, SK; Kiselová Beáta, Martin 8, SK;

(73) Kečka Stanislav, Ing., Poprad, SK; Janoščík Ján, Poprad, SK; Janoščíková Beáta, Poprad, SK; Kiselová Beáta, Martin 8, SK;

(74) Gruber Dalibor, Ing., Košice, SK;

**(54) Pohľadnice s ozdobou**

(28) 20

(55)

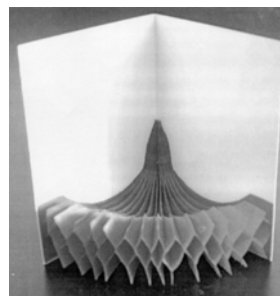

1.1

**7 (51) 14/02.03****(11) 26598**

(15) 06.02.2003

(18) 10.07.2007

(21) 142-2002

(22) 10.07.2002

(24) 06.02.2003

(31) 402 00 462.0

(32) 17.01.2002

(33) DE

(45) 01.04.2003

(72) Starič Janez, Trebnje, SI;

(73) ULTRA Proizvodnja elektronskih naprav d. o. o., Zagorje, SI;

(74) Majlingová Marta, Ing., Bratislava, SK;

**(54) Zariadenie na platobnú transakciu**

(28) 1

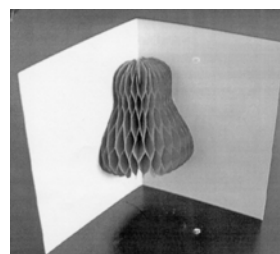

2.1

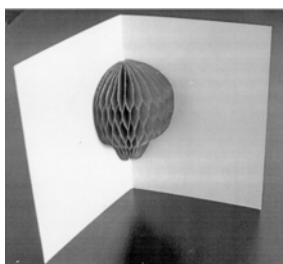

3.1

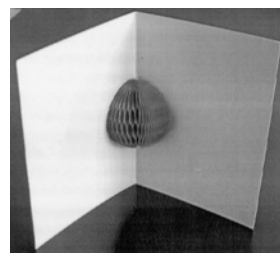

8.1

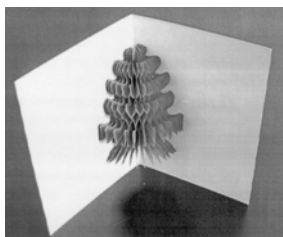

4.1

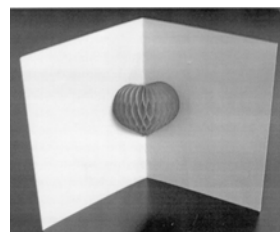

9.1



5.1

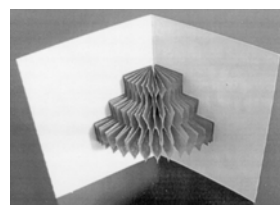

10.1

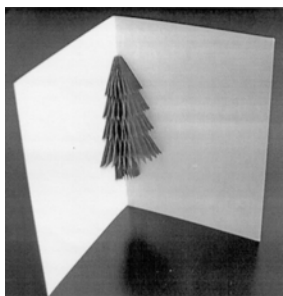

6.1

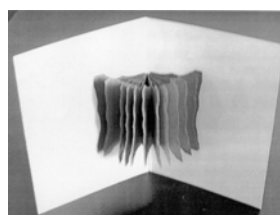

11.1

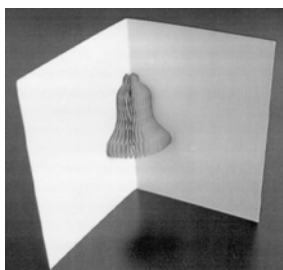

7.1

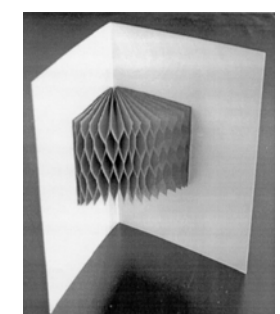

12.1

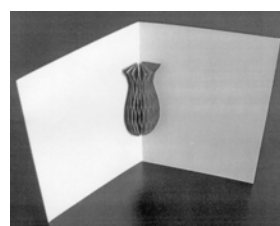

13.1

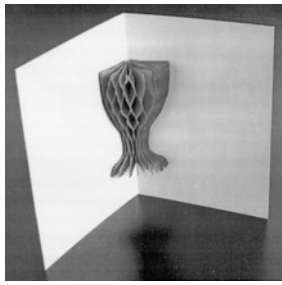

14.1

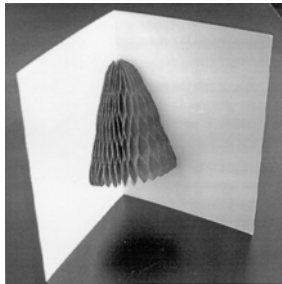

15.1

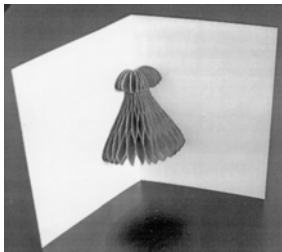

16.1

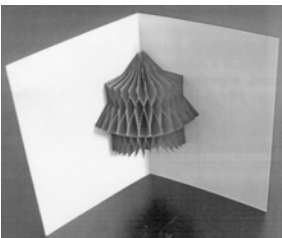

17.1

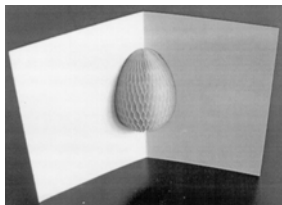

18.1

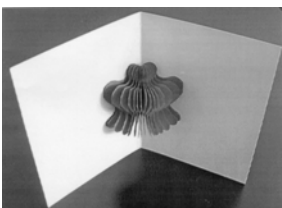

19.1

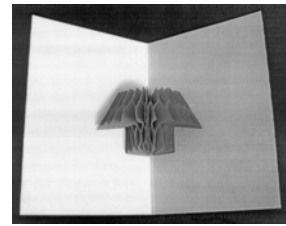

20.1

7 (51) 23/03.01

(11) 26597

(15) 06.02.2003

(18) 04.07.2007

(21) 140-2002

(22) 04.07.2002

(24) 06.02.2003

(45) 01.04.2003

(72) Chrenka Ferdinand, akad. sochár, Bratislava, SK;

(73) MORA SLOVAKIA, s. r. o., Bratislava, SK;

(74) Šujanová Mária, Ing., Bratislava, SK;

**(54) Plynové vykurovacie teleso**

(28) 1

(55)

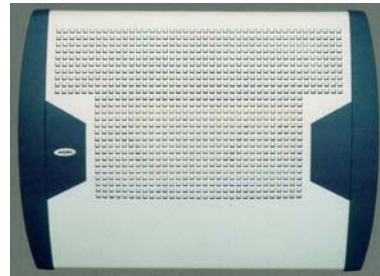

1.1

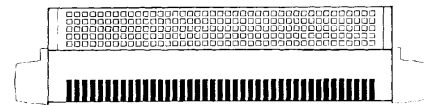

1.2



1.3



1.4

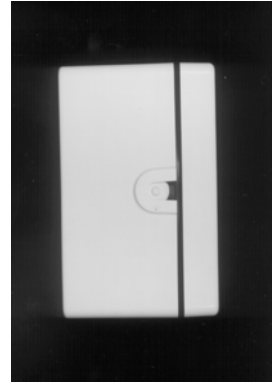

1.3

7 (51) 23/04.06

(11) 26602

(15) 06.02.2003

(18) 13.08.2007

(21) 166-2002

(22) 13.08.2002

(24) 06.02.2003

(31) MI2002O000108

(32) 18.02.2002

(33) IT

(45) 01.04.2003

(72) Trabucco Francesco, Milano, IT;

(73) VORTICE ELETTROSOCIALI S. p. A., Tribiano, IT;

(74) Majlingová Marta, Ing., Bratislava, SK;

(54) Odsávacie zariadenie

(28) 1

(55)

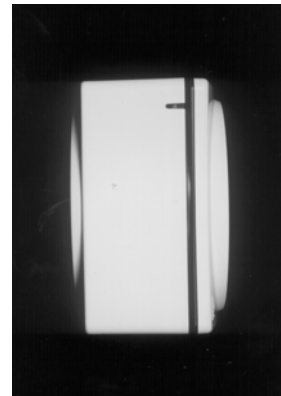

1.4



1.1



1.5

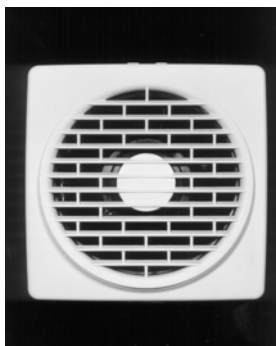

1.2

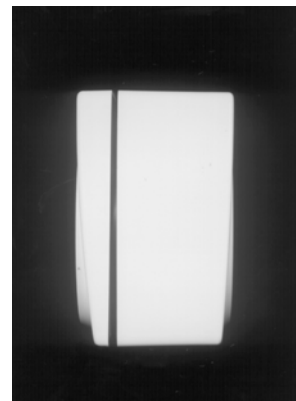

1.6



1.7



1.8



1.2



1.3

- 
- 7 (51) 24/04.06**  
**(11) 26593**  
 (15) 06.02.2003  
 (18) 09.04.2007  
 (21) 88-2002  
 (22) 09.04.2002  
 (24) 06.02.2003  
 (45) 01.04.2003  
 (72) Markech Pavol, Ing., Horná Streda, SK; Uváčik Dušan, Ing., Piešťany, SK; Bolerázsky Bohumil, Piešťany, SK;  
 (73) Chirana Progress, s. r. o., Piešťany, SK;  
 (74) Beleščák Ladislav, Ing., Piešťany, SK;  
**(54) Inhalátor**  
 (28) 1  
 (55)



1.1

- 
- 7 (51) 26/04.04**  
**(11) 26595**  
 (15) 06.02.2003  
 (18) 16.04.2007  
 (21) 91-2002  
 (22) 16.04.2002  
 (24) 06.02.2003  
 (45) 01.04.2003  
 (72) Lauková Oľga, Pobedim, SK;  
 (73) KOLLICHEMA, s. r. o., Piešťany, SK;  
 (74) Beleščák Ladislav, Ing., Piešťany, SK;  
**(54) Sviečka**  
 (28) 1  
 (55)



1.1

- 
- 7 (51) 28/01.00**  
**(11) 26600**  
 (15) 06.02.2003  
 (18) 26.07.2007  
 (21) 154-2002  
 (22) 26.07.2002  
 (24) 06.02.2003  
 (31) 29/154,888  
 (32) 30.01.2002  
 (33) US

- (45) 01.04.2003  
 (72) McAllister Stephen M., Harlow, Essex CM19  
 5AW, GB; Hewitt Brian, Hatfield, Hertfordshire,  
 GB;  
 (73) SmithKline Beecham plc, Brentford, Middlesex  
 TW8 9GS, GB;  
 (74) Majlingová Marta, Ing., Bratislava, SK;  
**(54) Kapsula**  
 (28) 8  
 (55)

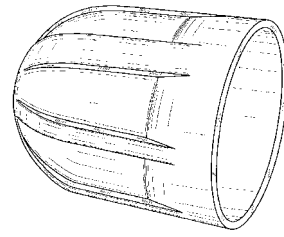

1.5

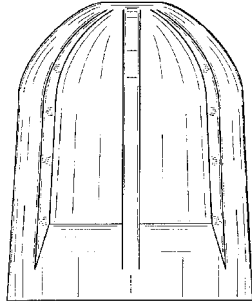

1.1

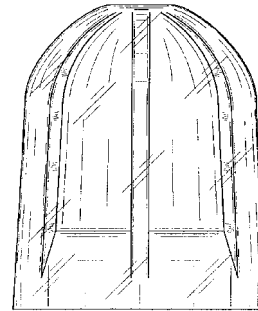

2.1

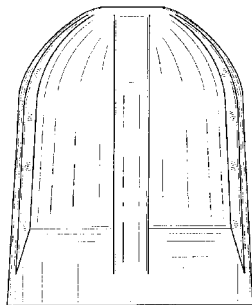

1.2

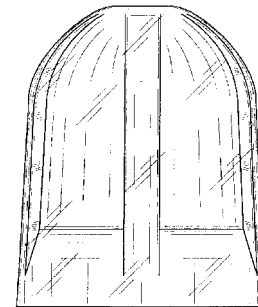

2.2

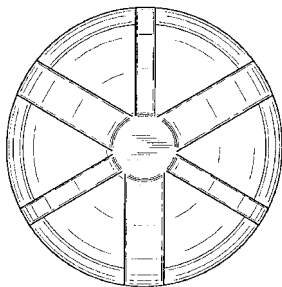

1.3

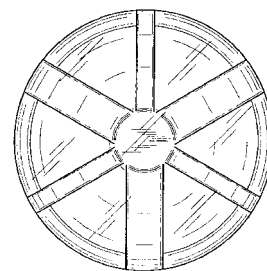

2.3

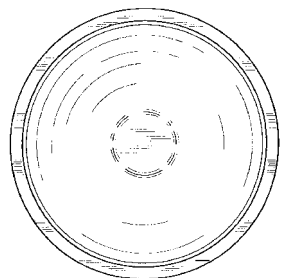

1.4

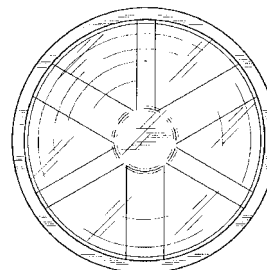

2.4

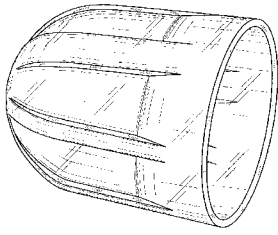

2.5

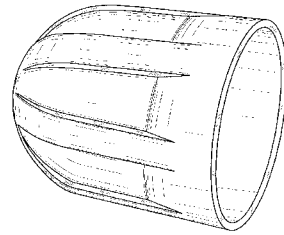

3.5

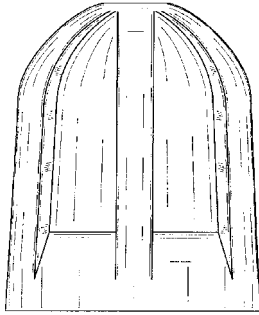

3.1

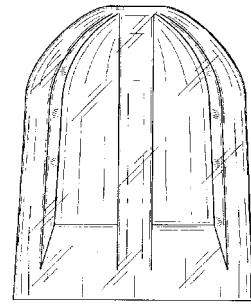

4.1

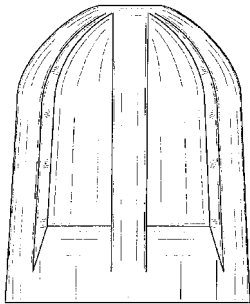

3.2

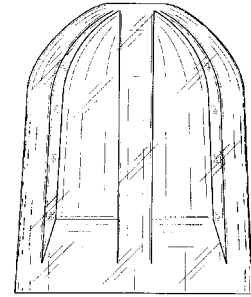

4.2

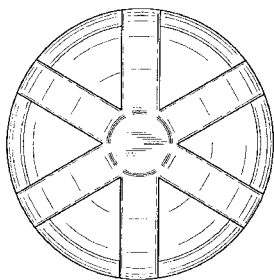

3.3

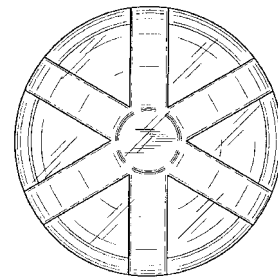

4.3

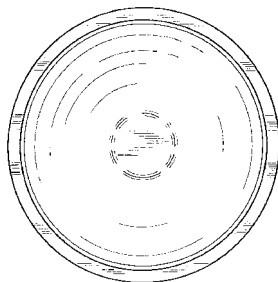

3.4

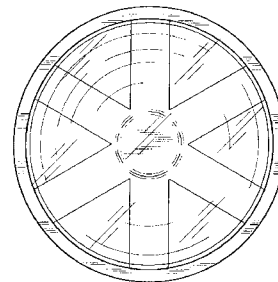

4.4

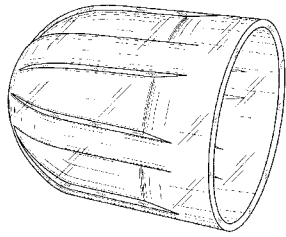

4.5

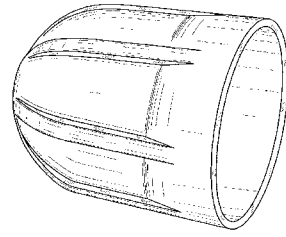

5.5

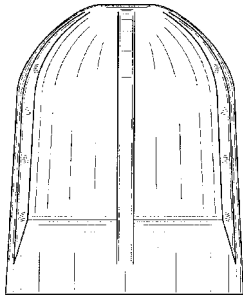

5.1

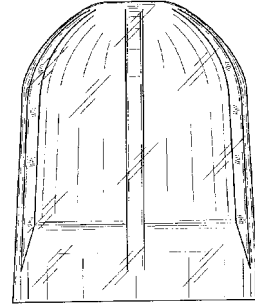

6.1

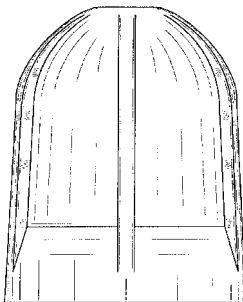

5.2

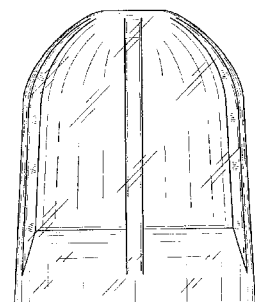

6.2

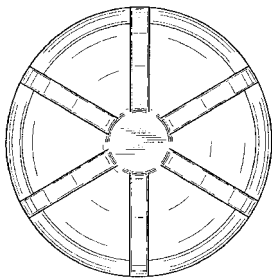

5.3

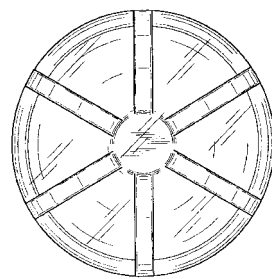

6.3

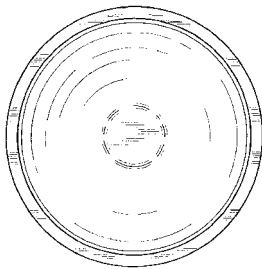

5.4

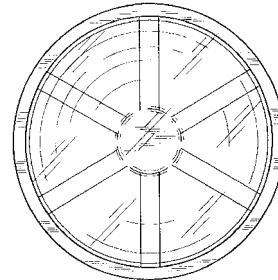

6.4



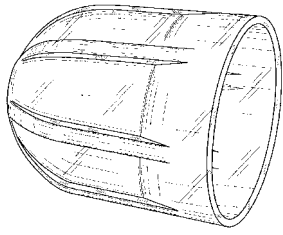

6.5

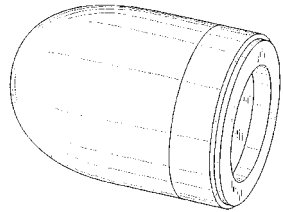

7.1

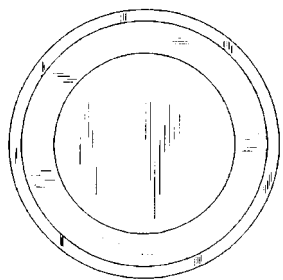

7.2

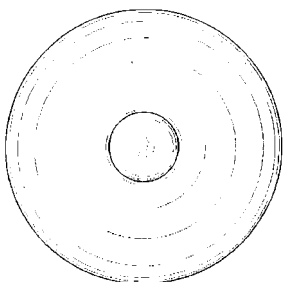

7.3

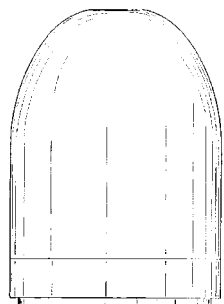

7.4

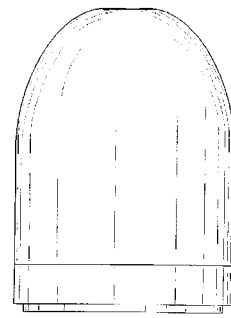

7.5

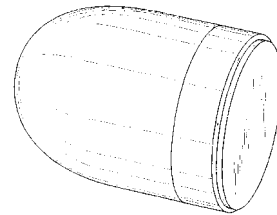

8.1

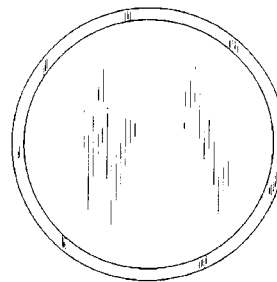

8.2

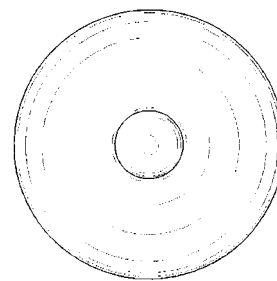

8.3

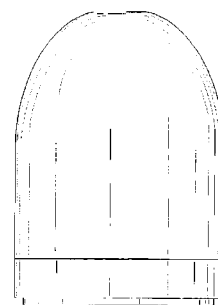

8.4

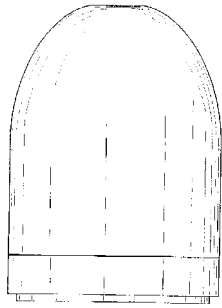

8.5

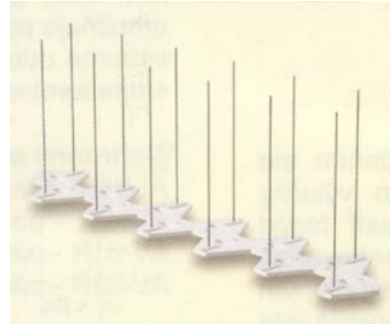

2.2

7 (51) 30/99.00

(11) 26594

(15) 06.02.2003

(18) 11.04.2007

(21) 89-2002

(22) 11.04.2002

(24) 06.02.2003

(45) 01.04.2003

(72) Vojtek Ľubomír, Zálesie, SK;

(73) Vojtek Ľubomír, Zálesie, SK;

(54) Ochrana budov pred holubmi

(28) 4

(55)

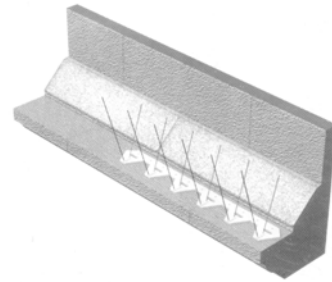

3.1

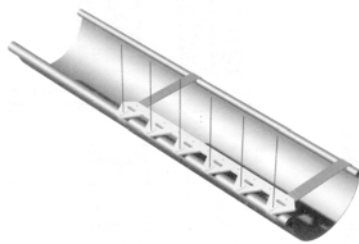

1.1

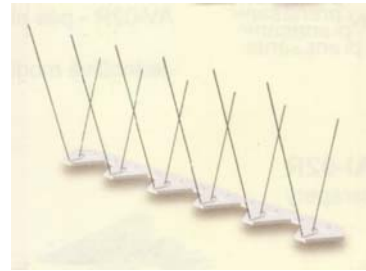

3.2

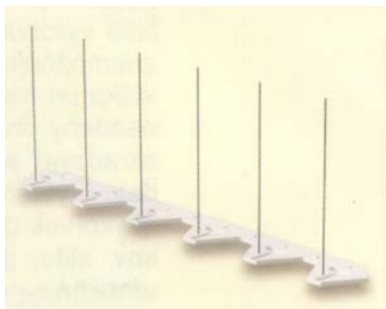

1.2

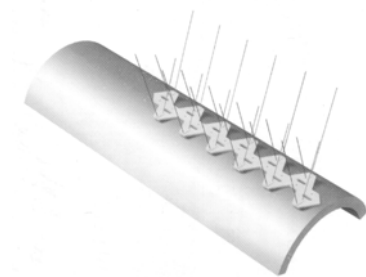

4.1

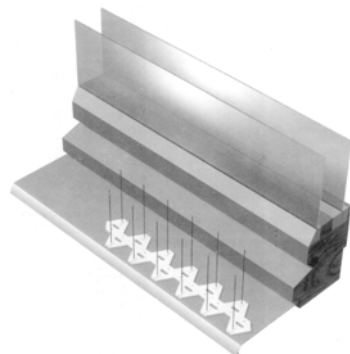

2.1

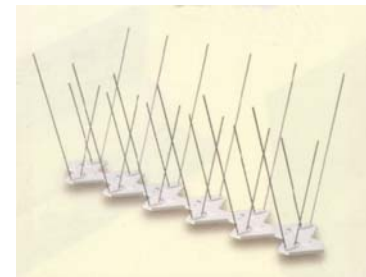

4.2

7 (51) 31/00.00

(11) 26599

(15) 06.02.2003

(18) 25.07.2007

(21) 153-2002

(22) 25.07.2002

(24) 06.02.2003

(31) PVZ 2002-34042

(32) 04.07.2002

(33) CZ

(45) 01.04.2003

(72) Jelínek Michal, Mladá Boleslav, CZ;

(73) Plzeňský Prazdroj, a. s., Plzeň, CZ;

(74) Dudová Tatiana, Trenčín, SK;

**(54) Výčapná hlava**

(28) 4

(55)

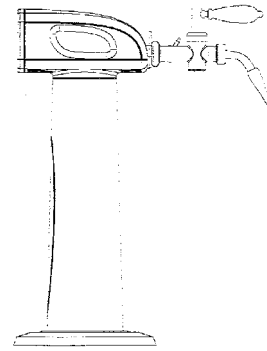

1.4

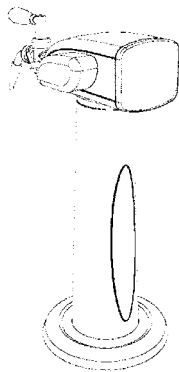

1.1

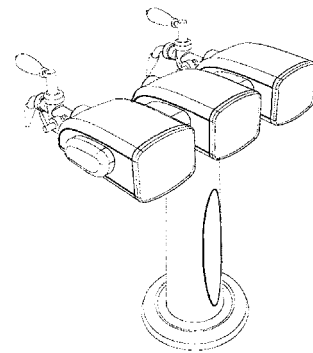

2.1

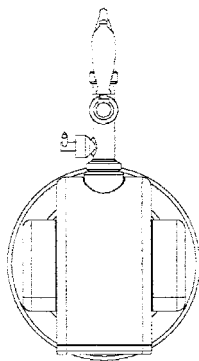

1.2

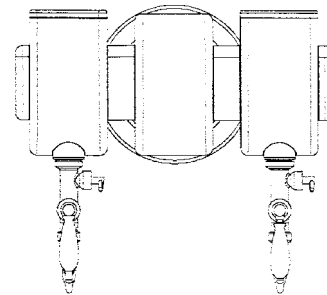

2.2

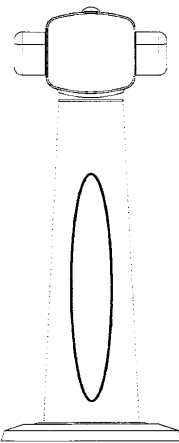

1.3

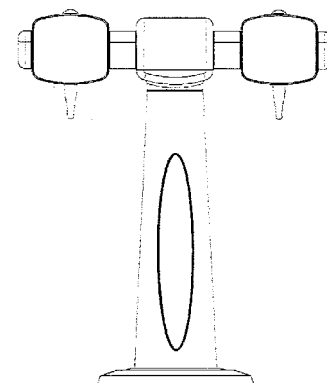

2.3

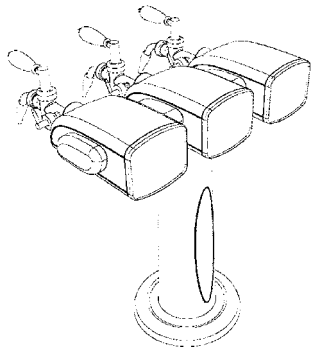

3.1

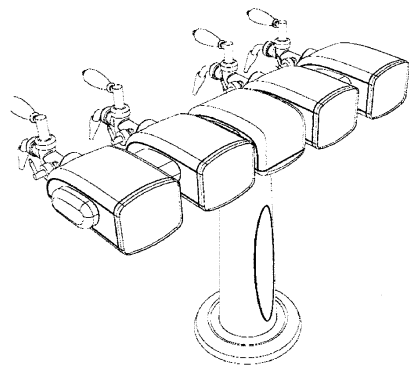

4.1

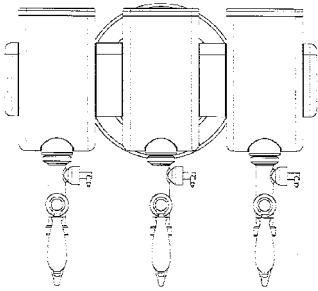

3.2

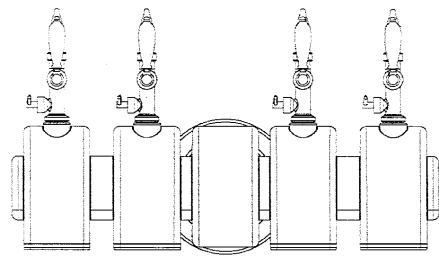

4.2

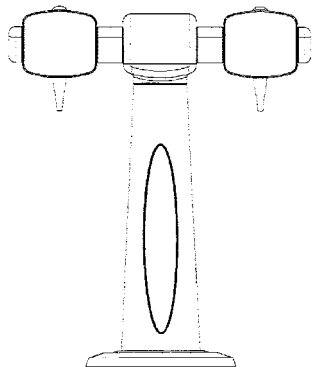

3.3

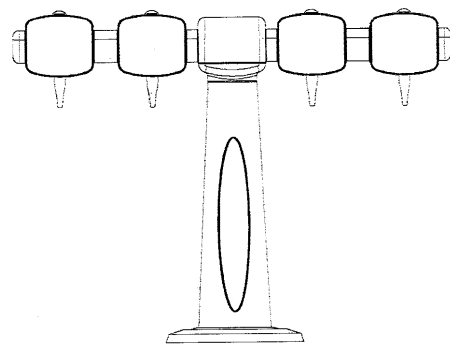

4.3

---

(51)	(11)	(51)	(11)	(51)	(11)	(51)	(11)
02/04.06	26601	13/03.03	26596	23/04.06	26602	30/99.00	26594
06/04.08	26603	14/02.03	26598	24/04.06	26593	31/00.00	26599
06/05.07	26592	19/01.00	26605	26/04.04	26595		
11/02.05	26604	23/03.01	26597	28/01.00	26600		

## ND4Q

## Predĺženie platnosti zapísaných dizajnov

(11)	(51)	(11)	(51)	(11)	(51)	(11)	(51)
24212	01/01.01	25544	24/02.06	25634	08/08.02	25678	08/07.00
25530	07/01.03	25576	07/01.03	25638	19/02.08	25695	24/02.05
25542	11/02.03	25608	13/03.03	25643	02/04.05	25701	04/02.01
25543	07/02.12	25619	25/02.04	25662	08/08.02	25714	09/01.01

**7 (51) 01/01.01****(11) 24212**

(15) 16.05.1994

(18) 17.12.2007

(21) 26217

(22) 17.12.1992

(73) BARILLA G. &amp; R. F. LLI S.p.A., PARMA, IT;

**(54) Toastový plátkový chlieb so špirálou****7 (51) 08/07.00****(11) 25678**

(15) 12.01.1999

(18) 22.05.2008

(21) 117-98

(22) 22.05.1998

(73) PCP, s. r. o., Bratislava, SK;

**(54) Telo zámku****7 (51) 02/04.05****(11) 25643**

(15) 24.11.1998

(18) 11.02.2008

(21) 37-98

(22) 11.02.1998

(73) Aigle International S.A., 75116 Paris, FR;

**(54) Jazdecká obuv****7 (51) 08/08.02****(11) 25662**

(15) 23.12.1998

(18) 22.05.2008

(21) 118-98

(22) 22.05.1998

(73) PCP, s. r. o., Bratislava, SK;

**(54) Rýchlopínací kĺb****7 (51) 04/02.01****(11) 25701**

(15) 04.03.1999

(18) 19.01.2008

(21) 12-98

(22) 19.01.1998

(73) UNILEVER NV, AL Rotterdam, NL;

**(54) Zubná kefka****7 (51) 08/08.02****(11) 25634**

(15) 27.10.1998

(18) 03.04.2008

(21) 80-98

(22) 03.04.1998

(73) PCP, s. r. o., Bratislava, SK;

**(54) Univerzálna príchytká plošného materiálu a jej časti****7 (51) 07/01.03****(11) 25576**

(15) 26.08.1998

(18) 13.08.2007

(21) 207-97

(22) 13.08.1997

(73) CRYSTALEX, a. s., Nový Bor, CZ;

**(54) Súbor nápojového skla****7 (51) 09/01.01****(11) 25714**

(15) 05.03.1999

(18) 09.06.2008

(21) 137-98

(22) 09.06.1998

(73) TATRACHEMA , výrobné družstvo, Trnava, SK;

**(54) Fľaša na saponát****7 (51) 07/01.03****(11) 25530**

(15) 11.06.1998

(18) 13.08.2007

(21) 206-97

(22) 13.08.1997

(73) CRYSTALEX, a. s., Nový Bor, CZ;

**(54) Súbor nápojového skla****7 (51) 11/02.03, 11/02.04****(11) 25542**

(15) 15.06.1998

(18) 28.11.2007

(21) 301-97

(22) 28.11.1997

(73) ARACARIA B.V., Amsterdam, NL;

**(54) Vázy, misky na kvety a ozdoby na stôl****7 (51) 07/02.12****(11) 25543**

(15) 15.06.1998

(18) 28.11.2007

(21) 302-97

(22) 28.11.1997

(73) ARACARIA B.V., Amsterdam, NL;

**(54) Vrchnáky na nádoby**

**7 (51) 13/03.03**  
**(11) 25608**  
 (15) 25.09.1998  
 (18) 23.02.2008  
 (21) 47-98  
 (22) 23.02.1998  
 (73) TESLA Stropkov, a.s., Stropkov, SK;  
**(54) Kryty**

**7 (51) 24/02.06**  
**(11) 25544**  
 (15) 15.06.1998  
 (18) 19.12.2007  
 (21) 321-97  
 (22) 19.12.1997  
 (73) ARACARIA B.V., Amsterdam, NL;  
**(54) Terapeutická lampa**

**7 (51) 19/02.08**  
**(11) 25638**  
 (15) 11.11.1998  
 (18) 02.03.2008  
 (21) 53-98  
 (22) 02.03.1998  
 (73) E K, s.r.o., Beluša, SK;  
**(54) Organizačná lišta na zakladače**

**7 (51) 25/02.04**  
**(11) 25619**  
 (15) 19.10.1998  
 (18) 19.02.2008  
 (21) 43-98  
 (22) 19.02.1998  
 (73) VALO Ľuboš - LAMINO, Očkov, SK;  
**(54) Skrinka**

**7 (51) 24/02.05**  
**(11) 25695**  
 (15) 20.01.1999  
 (18) 17.06.2008  
 (21) 144-98  
 (22) 17.06.1998  
 (73) N. V. Organon, AB Oss, NL;  
**(54) Aplikátor vaginálneho krúžku**

(51)	(11)	(51)	(11)	(51)	(11)	(51)	(11)
01/01.01	24212	07/01.03	25576	08/08.02	25662	19/02.08	25638
02/04.05	25643	07/02.12	25543	09/01.01	25714	24/02.05	25695
04/02.01	25701	08/07.00	25678	11/02.03	25542	24/02.06	25544
07/01.03	25530	08/08.02	25634	13/03.03	25608	25/02.04	25619

## PC4Q

## Prevody a prechody práv

**(11) 24940**  
 (21) 324-95  
 (58) 10.02.2003  
 (78) Texilan s. r. o., Bratislava, SK;  
 Názov / meno a adresa predchádzajúceho majiteľa(-ov): Tatrafan, akciová spoločnosť, Kežmarok, SK;  
 Dátum uzavretia zmluvy: 28.02.2002  
 Dátum účinnosti voči tretím osobám: 10.02.2003

**(11) 25333**  
 (21) 266-96  
 (58) 27.01.2003  
 (78) PCP, s. r. o., Bratislava, SK;  
 Názov / meno a adresa predchádzajúceho majiteľa(-ov): Červenko Jozef, Ing. arch., Bratislava, SK;  
 Dátum uzavretia zmluvy: 21.10.2002  
 Dátum účinnosti voči tretím osobám: 27.01.2003

**(11) 25332**  
 (21) 265-96  
 (58) 27.01.2003  
 (78) PCP, s. r. o., Bratislava, SK;  
 Názov / meno a adresa predchádzajúceho majiteľa(-ov): Červenko Jozef, Ing. arch., Bratislava, SK;  
 Dátum uzavretia zmluvy: 21.10.2002  
 Dátum účinnosti voči tretím osobám: 27.01.2003

**(11) 25384**  
 (21) 70-97  
 (58) 23.01.2003  
 (78) Diversy IP International BV, Luchthaven Schiphol Airport, NL;  
 Názov / meno a adresa predchádzajúceho majiteľa(-ov): UNILEVER NV, AL Rotterdam, NL;  
 Dátum uzavretia zmluvy: 14.08.2002  
 Dátum účinnosti voči tretím osobám: 23.01.2003

(11) **25634**  
 (21) 80-98  
 (58) 27.01.2003  
 (78) PCP, s. r. o., Bratislava, SK;  
 Názov / meno a adresa predchádzajúceho majiteľa(-ov): Červenko Jozef, Ing. arch., Bratislava, SK;  
 Dátum uzavretia zmluvy: 21.10.2002  
 Dátum účinnosti voči tretím osobám: 27.01.2003

(11) **25968**  
 (21) 195-99  
 (58) 23.01.2003  
 (78) TOD'S S.p.A., Sant' Elpidio a Mare, Ascoli Piceno, IT;  
 Názov / meno a adresa predchádzajúceho majiteľa(-ov): EMA SRL, I - 63044 Comunanza (Ascoli Piceno), IT;  
 Dátum účinnosti voči tretím osobám: 23.01.2003

(11) **25662**  
 (21) 118-98  
 (58) 27.01.2003  
 (78) PCP, s. r. o., Bratislava, SK;  
 Názov / meno a adresa predchádzajúceho majiteľa(-ov): Červenko Jozef, Ing. arch., Bratislava, SK;  
 Dátum uzavretia zmluvy: 21.10.2002  
 Dátum účinnosti voči tretím osobám: 27.01.2003

(11) **26162**  
 (21) 122-2000  
 (58) 14.02.2003  
 (78) YOPLAIT MARQUES INTERNATIONALES, Paris, FR;  
 Názov / meno a adresa predchádzajúceho majiteľa(-ov): SODIAAL INTERNATIONAL - Société de Diffusion Internationale Agro-Alimentaire, Paris, FR;  
 Dátum uzavretia zmluvy: 01.07.2002  
 Dátum účinnosti voči tretím osobám: 14.02.2003

(11) **25678**  
 (21) 117-98  
 (58) 27.01.2003  
 (78) PCP, s. r. o., Bratislava, SK;  
 Názov / meno a adresa predchádzajúceho majiteľa(-ov): Červenko Jozef, Ing. arch., Bratislava, SK;  
 Dátum uzavretia zmluvy: 21.10.2002  
 Dátum účinnosti voči tretím osobám: 27.01.2003

## QB4Q

## Registrované licenčné zmluvy

(11) **25745**  
 (21) 191-98  
 (58) 05.02.2003  
 (73) MODRATHERM SLOVAKIA, s.r.o., Modra, SK;  
 Nadobúdateľ: EVS Consulting, obchodnoekonomický servis, spol. s r. o., Modra, SK;  
 Druh licencie: zmluvná nevýlučná  
 Dátum uzavretia licenčnej zmluvy: 01.07.2002  
 Dátum účinnosti voči tretím osobám: 05.02.2003

MG4Q

Čiastočne vymazané zapísané dizajny

- (21) 185-2001  
 (22) 11.09.2001  
 (54) **Obaly na skupinu čajov HERBEX**  
 (58) 07.02.2003  
 V platnosti zostávajú dizajny: 01, 02, 03, 04, 05,  
 06, 08, 09, 10, 11, 12, 13, 14, 15, 16, 17  
 (55)



1.1



2.1

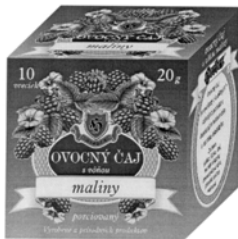

3.1



4.1

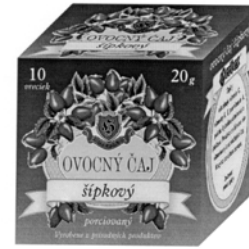

5.1



6.1



8.1

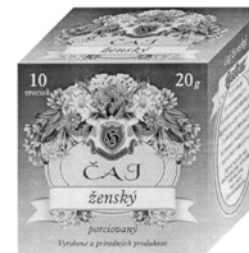

9.1



10.1





11.1



15.1

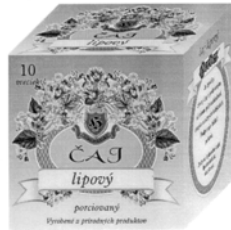

12.1



16.1



13.1



17.1



14.1

**MK4Q****Zaniknuté zapísané dizajny uplynutím doby platnosti**

(11)	Dátum zániku	(11)	Dátum zániku	(11)	Dátum zániku	(11)	Dátum zániku
21811	08.07.2002	25429	03.07.2002	25461	09.07.2002	25487	11.07.2002
24056	14.07.2002	25430	16.07.2002	25465	18.07.2002	25513	23.07.2002
24229	14.07.2002	25431	24.07.2002	25475	23.07.2002	25529	09.07.2002
25425	17.07.2002	25460	03.07.2002	25484	11.07.2002		